

## **DN6.22x - 24 channel 8 bit digitizerNETBOX up to 5 GS/s**

- 12, 16, 20 or 24 channels with 1.25 GS/s up to 5 GS/s
- Full signal bandwidth up to 1.5 GHz
- Simultaneously sampling on all channels
- Separate ADC and amplifier per channel
- complete on-board calibration
- 4 input ranges:  $\pm 200$  mV up to  $\pm 2.5$  V
- Low voltage input option:  $\pm 40$  mV up to  $\pm 500$  mV
- Programmable input offset of  $\pm 200\%$
- 12, 16, 20 or 24 GSample standard acquisition memory
- Window, re-arm, hysteresis, OR/AND trigger
- Features: Single-Shot, Streaming, ABA mode, Multiple Recording, Gated Sampling, Timestamps

### FPGA Options:

- Block Average up to 128k
- Block Statistics/Peak Detect



- Ethernet Remote Instrument
- LXI Core 2011 compatible
- GBit Ethernet Interface
- Sustained streaming mode up to 100 MB/s
- Direct Connection to PC/Laptop
- Connect anywhere in company LAN
- Embedded Webserver for Maintenance/Updates
- Embedded Server option for open Linux platform

### **Operating Systems**

- Windows 7 (SP1), 8, 10, Server 2008 R2 and newer
- Linux Kernel 2.6, 3.x, 4.x, 5.x
- Windows/Linux 32 and 64 bit

### **SBench 6 Professional Included**

- Acquisition, Generation and Display of analog and digital data
- Calculation, FFT
- Documentation and Import, Export

### **Drivers**

- LabVIEW, MATLAB, LabWindows/CVI
- C/C++, GNU C++, VB.NET, C#, J#, Delphi, Java, Python
- IVI

Model	Bandwidth	Channels @ 1.25 GS/s	Channels @ 2.5 GS/s	Channels @ 5 GS/s	Installed Memory
DN6.221-12	500 MHz	12	-	-	3 x 4 GS
DN6.221-16	500 MHz	16	-	-	4 x 4 GS
DN6.221-20	500 MHz	20	-	-	5 x 4 GS
DN6.221-24	500 MHz	24	-	-	6 x 4 GS
DN6.225-12	1.5 GHz	12	6	3	3 x 4 GS
DN6.225-16	1.5 GHz	16	8	4	4 x 4 GS
DN6.225-20	1.5 GHz	20	10	5	5 x 4 GS
DN6.225-24	1.5 GHz	24	12	6	6 x 4 GS

### **General Information**

The digitizerNETBOX DN6.22x series allows recording of up to 24 channels with sampling rates of up to 5 GS/s and a bandwidth of up to 1.5 GHz. These Ethernet Remote instruments offer outstanding A/D features both in bandwidth and signal quality.

The combination of high sampling rate and resolution makes these digitizers the top-of-the-range for applications that require high speed signal acquisition.

The digitizerNETBOX can be installed anywhere in the company LAN and can be remotely controlled from a host PC.

## Software Support

### Windows Support

The digitizerNETBOX/generatorNETBOX can be accessed from Windows 7, Windows 8, Windows 10 (each 32 bit and 64 bit). Programming examples for Visual C++, C++ Builder, LabWindows/CVI, Delphi, Visual Basic, VB.NET, C#, J#, Python, Java and IVI are included.

### Linux Support



The digitizerNETBOX/generatorNETBOX can be accessed from any Linux system. The Linux support includes SMP systems, 32 bit and 64 bit systems, versatile programming examples for Gnu C++, Python as well as drivers for MATLAB for Linux. SBench 6, the powerful data acquisition and analysis software from Spectrum is also included as a Linux version.

### Discovery Protocol

Physical Location	
Bus No	0
Device No	0
Function No	0
Slot No	0
IP	192.168.169.14
VISA	TCPIP[0]:192.168.169.14::INST0::INSTR

The Discovery function helps you to find and identify any Spectrum LXI instruments, like the digitizerNETBOX and generatorNETBOX, available to your computer on the network. The Discovery function will also locate any Spectrum card products that are managed by an installed Spectrum Remote Server somewhere on the network.

After running the discovery function the card information is cached and can be directly accessed by SBench 6. Furthermore the qualified VISA address is returned and can be used by any software to access the remote instrument.

### SBench 6 Professional

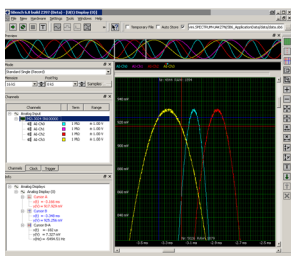

The digitizerNETBOX and generatorNETBOX can be used with Spectrum's powerful software SBench 6 – a Professional license for the software is already installed in the box. SBench 6 supports all of the standard features of the instrument. It has a variety of display windows as well as analysis, export and documentation

functions.

- Available for Windows XP, Vista, Windows 7, Windows 8, Windows 10 and Linux
- Easy to use interface with drag and drop, docking windows and context menus
- Display of analog and digital data, X-Y display, frequency domain and spread signals
- Designed to handle several GBytes of data
- Fast data preview functions

### IVI Driver

The IVI standards define an open driver architecture, a set of instrument classes, and shared software components. Together these provide critical elements needed for instrument interchangeability. IVI's defined Application Programming Interfaces (APIs) standardize common measurement functions reducing the time needed to learn a new IVI instrument.

The Spectrum products to be accessed with the IVI driver can be locally installed data acquisition cards, remotely installed data acquisition cards or remote LXI instruments like digitizerNETBOX/generatorNETBOX. To maximize the compatibility with existing IVI based software installations, the Spectrum IVI

driver supports IVI Scope, IVI Digitizer and IVI FGen class with IVI-C and IVI-COM interfaces.

### Third-party Software Products

Most popular third-party software products, such as LabVIEW, MATLAB or LabWindows/CVI are supported. All drivers come with examples and detailed documentation.

### Embedded Webserver



Instrument Welcome Page	
Instrument Model	DN2.465-08
Manufacturer	Spectrum GmbH
Serial Number	1234
Description	Spectrum GmbH, DN2.465-08, 1234, 3.32.13608
LXI Features	LXI Core 2011
LXI Version	LXI Device Specification 2011 rev. 1.4
Host Name	192.168.169.20
mDNS Host Name	DN2_465-08_sn1234.local
MAC Address	0C:C4:7A:B3:C2:A2
TCP/IP Address	192.168.169.20
Firmware Revision	40
Software Revision	3.32.13608
Instrument Address String [VISA]	TCPIP::192.168.169.20::INSTR
LAN ID Indicator	<input type="checkbox"/> Enable

The integrated webserver follows the LXI standard and gathers information on the product, set up of the Ethernet configuration and current status. It also allows the setting of a configuration password, access to documentation and updating of the complete instrument firmware, including the embedded remote server and the webserver.

## Hardware features and options

### LXI Instrument



The digitizerNETBOX and generatorNETBOX are fully LXI instrument compatible to LXI Core 2011 following the LXI Device Specification

2011 rev. 1.4. The digitizerNETBOX/generatorNETBOX has been tested and approved by the LXI Consortium.

Located on the front panel is the main on/off switch, LEDs showing the LXI and Acquisition status and the LAN reset switch.

### Front Panel



Standard SMA connectors are used for all analog input signals and all trigger and clock signals. No special adapter cables are needed and the connection is secure even when used in a moving environment.

Custom front panels are available on request even for small series, be it BNC, LEMO connectors or custom specific connectors.

### Ethernet Connectivity



The GBit Ethernet connection can be used with standard COTS Ethernet cabling. The integration into a standard LAN allows to connect the digitizerNETBOX/generatorNETBOX either directly to a desktop PC or Laptop or it is possible to place the instrument somewhere in the company LAN and access it from any desktop over the LAN.

### Boot on Power on Option

The digitizerNETBOX/generatorNETBOX can be factory configured to automatically start and boot upon availability of the input power rail. That way the instrument will automatically become available again upon loss of input power.

## Input Amplifier

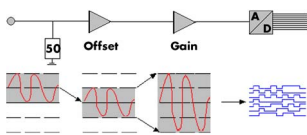

The analog inputs can be adapted to real world signals using a wide variety of settings that are individual for each channel. By using software commands one can select a matching input range and the signal offset can be compensated by programmable AC coupling or offset shifting.

## Software selectable lowpass filter

Each analog channel contains a software selectable low-pass filter to limit the input bandwidth. Reducing the analog input bandwidth results in a lower total noise and can be useful especially with low voltage input signals.

## Automatic on-board calibration

Every channel of each card is calibrated in the factory before the board is shipped. However, to compensate for environmental variations like PC power supply, temperature and aging the software driver includes routines for automatic offset and gain calibration. This calibration is performed on all input ranges of the "Buffered" path and uses a high precision onboard calibration reference.

## Digital inputs

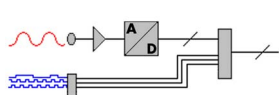

This option acquires additional synchronous digital channels phase-stable with the analog data. As default a maximum of 3 additional digital inputs are available on the front plate of the card using the multi-purpose I/O lines. An additional option offers 16 more digital channels.

## Ring buffer mode

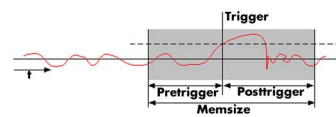

The ring buffer mode is the standard mode of all oscilloscope instruments. Digitized data is continuously written into a ring memory until a trigger event is detected.

After the trigger, post-trigger samples are recorded and pre-trigger samples can also be stored. The number of pre-trigger samples available simply equals the total ring memory size minus the number of post trigger samples.

## FIFO mode

The FIFO mode is designed for continuous data transfer between remote instrument and PC memory or hard disk. The control of the data stream is done automatically by the driver on interrupt request. The complete installed on-board memory is used for buffer data, making the continuous streaming extremely reliable.

## Channel trigger

The data acquisition instruments offer a wide variety of trigger modes. Besides the standard signal checking for level and edge as known from oscilloscopes it's also possible to define a window trigger. All trigger modes can be combined with the pulsewidth trigger. This makes it possible to trigger on signal errors like too long or too short pulses. In addition to this a re-arming mode (for accurate trigger recognition on noisy signals) the AND/OR conjunction of different trigger events is possible. As a unique feature it is possible to use deactivated channels as trigger sources.

## External trigger input

All boards can be triggered using up to two external analog or digital signals. One external trigger input has two analog comparators that can define an edge or window trigger, a hysteresis trigger or a rearm trigger. The other input has one comparator that can be used for standard edge and level triggers.

## Multiple Recording

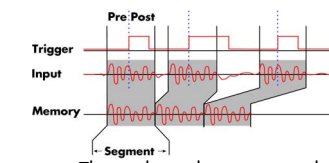

The Multiple Recording mode allows the recording of several trigger events with an extremely short re-arming time. The hardware doesn't need to be restarted in between. The on-board memory is divided in several segments of the same size. Each of them is filled with data if a trigger event occurs. Pre- and posttrigger of the segments can be programmed. The number of acquired segments is only limited by the used memory and is unlimited when using FIFO mode.

## Gated Sampling

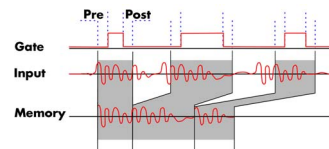

The Gated Sampling mode allows data recording controlled by an external gate signal. Data is only recorded if the gate signal has a programmed level. In addition a pre-area before start

of the gate signal as well as a post area after end of the gate signal can be acquired. The number of gate segments is only limited by the used memory and is unlimited when using FIFO mode.

## Timestamp

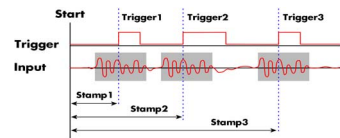

The timestamp function writes the time positions of the trigger events in an extra memory. The timestamps are relative to the start of recording, a defined zero time, externally synchronized to a radio clock, an IRIG-B or a GPS receiver.

Using the external synchronization gives a precise time relation for acquisitions of systems on different locations.

## ABA mode

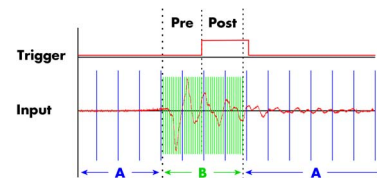

The ABA mode combines slow continuous data recording with fast acquisition on trigger events. The ABA mode works like a slow data logger combined with a fast digitizer. The exact

position of the trigger events is stored as timestamps in an extra memory.

## Firmware Option Block Average

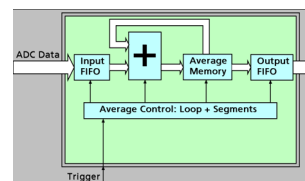

The Block Average Module improves the fidelity of noisy repetitive signals. Multiple repetitive acquisitions with very small dead-time are accumulated and averaged. Random noise is reduced by the averaging process improving

the visibility of the repetitive signal. The complete averaging process is done inside the FPGA of the digitizer generating no CPU load at all. The amount of data is greatly decreased as well as the needed transfer bandwidth is heavily reduced.

Please see separate data sheet for details on the firmware option.

### **Firmware Option Block Statistics (Peak Detect)**

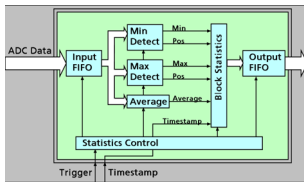

The Block Statistics and Peak Detect Module implements a widely used data analysis and reduction technology in hardware. Each block is scanned for minimum and maximum peak and a summary including minimum, maximum, average,

timestamps and position information is stored in memory. The complete averaging process is done inside the FPGA of the digitizer generating no CPU load at all. The amount of data is greatly decreased as well as the needed transfer bandwidth is heavily reduced.

Please see separate data sheet for details on the firmware option.

### **Option Embedded Server**

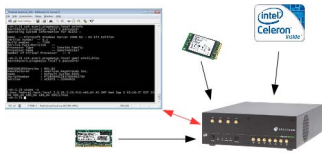

The option turns the digitizer-NETBOX/generatorNETBOX in a powerful PC that allows to run own programs on a small and remote data acquisition system. The digitizerNET-

BOX/generatorNETBOX is enhanced by more memory, a powerful CPU, a freely accessible internal SSD and a remote software development access method.

The digitizerNETBOX/generatorNETBOX can either run connected to LAN or it can run totally independent, storing data to the internal SSD. The original digitizerNETBOX/generatorNETBOX remote instrument functionality is still 100 % available. Running the embedded server option it is possible to pre-calculate results based on the acquired data, store acquisitions locally and to transfer just the required data or results parts in a client-server based software structure. A different example for the digitizerNETBOX/generatorNETBOX embedded server is surveillance/logger application which can run totally independent for days and send notification emails only over LAN or offloads stored data as soon as it's connected again.

Access to the embedded server is done through a standard text based Linux shell based on the ssh secure shell.

### **External clock input and output**

Using a dedicated connector a sampling clock can be fed in from an external system. Additionally it's also possible to output the internally used sampling clock on a separate connector to synchronize external equipment to this clock.

### **Reference clock**

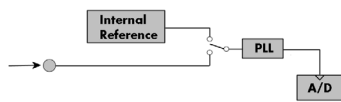

The option to use a precise external reference clock (normally 10 MHz) is necessary to synchronize the instrument for high-quality

measurements with external equipment (like a signal source). It's also possible to enhance the quality of the sampling clock in this way. The driver automatically generates the requested sampling clock from the fed in reference clock.

## DN2 / DN6 Technical Data

### Analog Inputs

Resolution		8 Bit
Input Type		Single-ended
ADC Differential non linearity (DNL)	ADC only	±0.35 LSB
ADC Integral non linearity (INL)	ADC only	±0.9 LSB
ADC Bit Error Rate (BER)	sampling rate 1.25 GS/s	10 <sup>-16</sup>
Channel selection	software programmable	1, 2, or 4 (maximum is model dependent)
Analog Input impedance	fixed	50 Ω
Input Ranges (standard ranges)	software programmable	±200 mV, ±500 mV, ±1 V, ±2.5 V (programmable input offset at 0%)
Input Ranges (Low Voltage Option)	software programmable	±40 mV, ±100 mV, ±200 mV, ±500 mV (programmable input offset at 0%)
Programmable Input Offset	software programmable	±200% of input range (allowing bi-polar ranges to become uni-polar)
Input Coupling	software programmable	AC/DC
Max DC voltage if AC coupling active		±30 V
Offset error (full speed)	after warm-up and calibration	< 0.5 LSB
Gain error (full speed)	after warm-up and calibration	< 2.0 LSB
Crosstalk 20 MHz sine signal (standard ranges)	≥ ±500 mV standard range	< -96 dB (all channel same input range)
Crosstalk 20 MHz sine signal (standard ranges)	= ±200 mV standard range	< -88 dB (all channel same input range)
Crosstalk 100 MHz sine signal (standard ranges)	≥ ±500 mV standard range	< -78 dB (all channel same input range)
Crosstalk 100 MHz sine signal (standard ranges)	= ±200 mV standard range	< -65 dB (all channel same input range)

Over voltage protection (standard ranges)	input range	±200 mV	±500 mV	±1 V	±2.5 V
	max. continuous input power	22.5 dBm	27.0 dBm	27.0 dBm	27.0 dBm
	max. peak input voltage	±3 V	±7.5 V	±15 V	±30 V

Over voltage protection (low voltage option)	input range	±40 mV	±100 mV	±200 mV	±500 mV
	max. continuous input power	21.0 dBm	27.0 dBm	22.5 dBm	27.0 dBm
	max. peak input voltage	±2.5 V	±6.25 V	±3 V	±7.5 V

### Trigger

Available trigger modes	software programmable	Channel Trigger, External, Software, Window, Re-Arm, Or/And, Delay, PXI (M4x only)
Channel trigger level resolution	software programmable	14 bit
Trigger engines		1 engine per channel with two individual levels, 2 external triggers
Trigger edge	software programmable	Rising edge, falling edge or both edges
Trigger delay	software programmable	0 to (8GSamples - 32) = 8589934560 Samples in steps of 32 samples
Multi, ABA, Gate: re-arming time	1.25 GS/s or below 2.5 GS/s 5 GS/s	80 samples (+ programmed pretrigger) 160 samples (+ programmed pretrigger) 320 samples (+ programmed pretrigger)
Pretrigger at Multi, ABA, Gate, FIFO	software programmable	32 up to 8192 Samples in steps of 32
Posttrigger	software programmable	32 up to 16G samples in steps of 32 (defining pretrigger in standard scope mode)
Memory depth	software programmable	64 up to [installed memory / number of active channels] samples in steps of 32
Multiple Recording/ABA segment size	software programmable	64 up to [installed memory / 2 / active channels] samples in steps of 32
Trigger accuracy (all sources)		1 sample
Timestamp modes	software programmable	Standard, Startreset, external reference clock on X0 (e.g. PPS from GPS, IRIG-B)
Data format		Std., Startreset: 64 bit counter, increments with sample clock (reset manually or on start) RefClock: 24 bit upper counter (increment with RefClock) 40 bit lower counter (increments with sample clock, reset with RefClock)
Extra data	software programmable	none, acquisition of X0/X1/X2 inputs at trigger time, trigger source (for OR trigger)
Size per stamp		128 bit = 16 bytes
External trigger		<b>Ext0</b>
External trigger impedance	software programmable	50 Ω / 1 kΩ
External trigger coupling	software programmable	AC or DC
External trigger type		Window comparator
External input level		±10 V (1 kΩ), ±2.5 V (50 Ω), 2.5% of full scale range
External trigger sensitivity (minimum required signal swing)		2.5% of full scale range = 0.5 V
External trigger level	software programmable	±10 V in steps of 1 mV ±30V
External trigger maximum voltage		±10 V in steps of 1 mV ±30 V
External trigger bandwidth DC	50 Ω 1 kΩ	n.a. DC to 200 MHz
External trigger bandwidth AC	50 Ω	20 kHz to 200 MHz n.a.
Minimum external trigger pulse width		≥ 2 samples ≥ 2 samples
		<b>Ext1</b>
		1 kΩ
		fixed DC
		Single level comparator
		±10 V

## Clock

Clock Modes	software programmable	internal PLL, external reference clock, Star-Hub sync (M4i only), PXI Reference Clock (M4x only)
Internal clock accuracy		≤ ±20 ppm
Clock setup granularity		divider: maximum sampling rate divided by: 1, 2, 4, 8, 16, ... up to 262144
External reference clock range	software programmable	≥ 10 MHz and ≤ 1.25 GHz
External reference clock input impedance		50 Ω fixed
External reference clock input coupling		AC coupling
External reference clock input edge		Rising edge
External reference clock input type		Single-ended, sine wave or square wave
External reference clock input swing		0.3 V peak-peak up to 3.0 V peak-peak
External reference clock input max DC voltage		±30 V (with max 3.0 V difference between low and high level)
External reference clock input duty cycle requirement		45% to 55%
Clock setup granularity when using reference clock		divider: maximum sampling rate divided by: 1, 2, 4, 8, 16, ... up to 262144
Internal reference clock output type		Single-ended, 3.3V LVPECL
Internal reference clock output frequency		2.5 GHz / 64 = 39.0625 MHz
Star-Hub synchronization clock modes	software selectable	Internal clock (standard clock mode only), External reference clock
ABA mode clock divider for slow clock	software programmable	16 up to (128k - 16) in steps of 16
Channel to channel skew on one card		< 60 ps (typical)
Skew between star-hub synchronized cards		< 130 ps (typical, preliminary)

	M4i.223x DN2.223-xx DN2.225-xx DN6.225-xx	M4i.222x DN2.222-xx	M4i.221x DN2.221-xx DN6.221-xx
ADC Resolution	8 bit	8 bit	8 bit
max sampling clock	5 GS/s	2.5 GS/s	1.25 GS/s
min sampling clock	4.768 kS/s	4.768 kS/s	4.768 kS/s
lower bandwidth limit (DC coupling)	0 Hz	0 Hz	0 Hz
lower bandwidth limit (AC coupling)	< 30 kHz	< 30 kHz	< 30 kHz
-3 dB bandwidth (no filter active), Standard input ranges	1.5 GHz	1.5 GHz	500 MHz
-3 dB bandwidth (no filter active), small input ranges, ir40m option installed	1.2 GHz	1.2 GHz	500 MHz
-3 dB bandwidth (BW filter active)	~400 MHz	~400 MHz	~370 MHz

## Block Average Signal Processing Option M4i.22xx/DN2.22x/DN6.22x Series

		Firmware ≥ V1.14 (since August 2015)		Firmware < V1.14
		32 bit mode	16 bit mode	32 bit mode only
Data Mode (resulting sample width)	software programmable	32 samples	128 samples	32 samples
Minimum Waveform Length		32 samples	64 samples	32 samples
Minimum Waveform Stepsize		64 kSamples	128 kSamples	32 kSamples
Maximum Waveform Length	1 channel active	32 kSamples	64 kSamples	16 kSamples
Maximum Waveform Length	2 channels active	16 kSamples	32 kSamples	8 kSamples
Maximum Waveform Length	4 or more channels active	2	2	4
Minimum Number of Averages		16777216 (16M)	256	16777216 (16M)
Maximum Number of Averages				
Data Output Format	fixed	32 bit signed integer	16 bit signed integer	32 bit signed integer
Re-Arming Time between waveforms	1.25 GS/s or below	80 samples (+ programmed pretrigger)		80 samples (+ programmed pretrigger)
Re-Arming Time between waveforms	2.5 GS/s	160 samples (+ programmed pretrigger)		160 samples (+ programmed pretrigger)
Re-Arming Time between waveforms	5 GS/s	320 samples (+ programmed pretrigger)		320 samples (+ programmed pretrigger)
Re-Arming Time between end of average to start of next average		Depending on programmed segment length, max 50 μs		80/160/320 samples as above listed

## Block Statistics Signal Processing Option M4i.22xx/DN2.22x Series/DN6.22x Series

Minimum Waveform Length		64 samples
Minimum Waveform Stepsize		32 samples
Maximum Waveform Length	Standard Acquisition	2 GSamples / channels
Maximum Waveform Length	FIFO Acquisition	2 GSamples
Data Output Format	fixed	32 bytes statistics summary
Statistics Information Set per Waveform		Average, Minimum, Maximum, Position Minimum, Position Maximum, Trigger Timestamp
Re-Arming Time between Segments	1.25 GS/s or below	80 samples (+ programmed pretrigger)
Re-Arming Time between Segments	2.5 GS/s	160 samples (+ programmed pretrigger)
Re-Arming Time between Segments	5 GS/s	320 samples (+ programmed pretrigger)

## **Multi Purpose I/O lines (front-plate)**

Number of multi purpose lines		three, named X0, X1, X2
Input: available signal types	software programmable	Asynchronous Digital-In, Synchronous Digital-In, Timestamp Reference Clock
Input: impedance		10 k $\Omega$ to 3.3 V
Input: maximum voltage level		-0.5 V to +4.0 V
Input: signal levels		3.3 V LVTTTL
Input: bandwidth		125 MHz
Output: available signal types	software programmable	Asynchronous Digital-Out, Trigger Output, Run, Arm, PLL Refclock, System Clock
Output: impedance		50 $\Omega$
Output: signal levels		3.3 V LVTTTL
Output: type		3.3V LVTTTL, TTL compatible for high impedance loads
Output: drive strength		Capable of driving 50 $\Omega$ loads, maximum drive strength $\pm 48$ mA
Output: update rate	14bit, 16 bit ADC resolution	sampling clock
Output: update rate	8 bit ADC resolution	Current sampling clock $\leq 1.25$ GS/s : sampling clock Current sampling clock $> 1.25$ GS/s and $\leq 2.50$ GS/s : $\frac{1}{2}$ sampling clock Current sampling clock $> 2.50$ GS/s and $\leq 5.00$ GS/s : $\frac{1}{4}$ sampling clock

## **Connectors**

Analog Channels		SMA female (one for each single-ended input)	Cable-Type: Cab-3mA-xx-xx
Clock Input		SMA female	Cable-Type: Cab-3mA-xx-xx
Clock Output		SMA female	Cable-Type: Cab-3mA-xx-xx
Trg0 Input		SMA female	Cable-Type: Cab-3mA-xx-xx
Trg1 Input		SMA female	Cable-Type: Cab-3MAxx-xx
X0/Trigger Output/Timestamp Reference Clock	programmable direction	SMA female	Cable-Type: Cab-3mA-xx-xx
X1	programmable direction	SMA female	Cable-Type: Cab-3mA-xx-xx
X2	programmable direction	SMA female	Cable-Type: Cab-3mA-xx-xx

## **Option digitizerNETBOX/generatorNETBOX embedded server (DN2.xxx-Emb, DN6.xxx-Emb)**

CPU		Intel Quad Core 2 GHz
System memory		4 GByte RAM
System data storage		Internal 128 GByte SSD
Development access		Remote Linux command shell (ssh), no graphical interface (GUI) available
Accessible Hardware		Full access to Spectrum instruments, LAN, front panel LEDs, RAM, SSD
Integrated operating system		OpenSuse 12.2 with kernel 4.4.7.
Internal PCIe connection		DN2.20, DN2.46, DN2.47, DN2.49, DN2.59, DN2.60      PCIe x1, Gen1 DN6.46, DN6.49, DN6.59 DN2.22, DN2.44, DN2.66      PCIe x1, Gen2 DN6.22, DN6.44, DN6.66

## **Ethernet specific details**

LAN Connection		Standard RJ45
LAN Speed		Auto Sensing: GBit Ethernet, 100BASE-T, 10BASE-T
LAN IP address	programmable	DHCP (IPv4) with AutoIP fall-back (169.254.x.y), fixed IP (IPv4)
Sustained Streaming speed		DN2.20, DN2.46, DN2.47, DN2.49, DN2.60      up to 70 MByte/s DN6.46, DN6.49 DN2.59, DN2.22, DN2.44, DN2.66      up to 100 MByte/s DN6.59, DN6.22, DN6.44, DN6.66
Used TCP/UDP Ports		Webserver: 80      mDNS Daemon: 5353 VISA Discovery Protocol: 111, 9757      UPNP Daemon: 1900 Spectrum Remote Server: 1026, 5025

## **Power connection details**

Mains AC power supply		Input voltage: 100 to 240 VAC, 50 to 60 Hz
AC power supply connector		IEC 60320-1-C14 (PC standard coupler)
Power supply cord		power cord included for Schuko contact (CEE 7/7)

## **Certification, Compliance, Warranty**

EMC Immunity		Compliant with CE Mark
EMC Emission		Compliant with CE Mark
Product warranty		5 years starting with the day of delivery
Software and firmware updates		Life-time, free of charge

## Dynamic Parameters

<b>M4i.223x, M4x.223x and DN2.223-xx, DN2.225-xx and DN6.225-xx, 8 Bit 5 GS/s</b>												
DC or AC coupled, fixed 50 Ohm												
Test signal frequency												
10 MHz                      40 MHz                      70 MHz                      240 MHz                      600 MHz												
Input Range												
±200 mV   ±500 mV   ±1 V   ±2.5 V   ±200 mV   ±1V   ±200 mV   ±1V   ±200 mV   ±1V   ±200 mV   ±1V												
THD (typ) (dB)	<60.2 dB	<60.3 dB	<60.3 dB	<60.3 dB	<58.9 dB	<58.2 dB	<58.8 dB	<58.0 dB	<54.0 dB	<54.0 dB	<45.0 dB	<46.3 dB
SNR (typ) (dB)	>44.5 dB	>44.8 dB	>44.8 dB	>44.5 dB	>44.7 dB	>44.7 dB	>44.3 dB	>44.3 dB	>42.9 dB	>42.9 dB	>40.3 dB	>40.2 dB
SFDR (typ), excl. harm. (dB)	>53.7 dB	>54.9 dB	>54.9 dB	>54.2 dB	>50.3 dB	>50.8 dB	>50.2 dB	>49.7 dB	>49.4 dB	>49.5 dB	>44.3 dB	>44.6 dB
SFDR (typ), incl. harm. (dB)	>53.7 dB	>54.7 dB	>54.8 dB	>54.2 dB	>50.3 dB	>50.8 dB	>50.2 dB	>49.7 dB	>49.4 dB	>49.5 dB	>44.3 dB	>44.6 dB
SINAD/THD+N (typ) (dB)	>44.4 dB	>44.7 dB	>44.7 dB	>44.4 dB	>44.5 dB	>44.4 dB	>44.2 dB	>44.1 dB	>42.6 dB	>42.6 dB	>39.1 dB	>39.3 dB
ENOB based on SINAD (bit)	>7.1 bit	>7.1 bit	>7.1 bit	>7.1 bit	>7.1 bit	>7.1 bit	>7.1 bit	>7.0 bit	>6.8 bit	>6.8 bit	>6.2 bit	>6.2 bit
ENOB based on SNR (bit)	>7.1 bit	>7.1 bit	>7.1 bit	>7.1 bit	>7.1 bit	>7.1 bit	>7.1 bit	>7.1 bit	>6.9 bit	>6.9 bit	>6.4 bit	>6.4 bit

<b>M4i.222x, M4x.222x and DN2.222-xx, 8 Bit 2.5 GS/s</b>												
DC or AC coupled, fixed 50 Ohm												
Test signal frequency												
10 MHz                      40 MHz                      70 MHz                      240 MHz                      600 MHz												
Input Range												
±200 mV   ±500 mV   ±1 V   ±2.5 V   ±200 mV   ±1V   ±200 mV   ±1V   ±200 mV   ±1V   ±200 mV   ±1V												
THD (typ) (dB)	>56.2 dB	<56.3 dB	<56.5 dB	<56.4 dB	<55.9 dB	<55.9 dB	<54.9 dB	<55.3 dB	<53.9 dB	<53.4 dB	<43.9 dB	<45.2 dB
SNR (typ) (dB)	>45.6 dB	>45.8 dB	>45.6 dB	>45.5 dB	>44.7 dB	>44.9 dB	>44.5 dB	>44.6 dB	>43.9 dB	>44.0 dB	>42.1 dB	>41.9 dB
SFDR (typ), excl. harm. (dB)	>57.2 dB	>57.3 dB	>55.7 dB	>55.1 dB	>50.9 dB	>50.5 dB	>50.9 dB	>50.6 dB	>49.8 dB	>49.0 dB	>46.3 dB	>45.2 dB
SFDR (typ), incl. harm. (dB)	>56.5 dB	>56.3 dB	>55.1 dB	>54.5 dB	>50.9 dB	>50.5 dB	>50.9 dB	>50.6 dB	>49.8 dB	>49.0 dB	>45.2 dB	>45.2 dB
SINAD/THD+N (typ) (dB)	>45.2 dB	>45.4 dB	>45.3 dB	>45.2 dB	>44.4 dB	>44.4 dB	>44.2 dB	>44.3 dB	>43.5 dB	>43.5 dB	>39.9 dB	>40.2 dB
ENOB based on SINAD (bit)	>7.2 bit	>7.3 bit	>7.2 bit	>7.2 bit	>7.1 bit	>7.1 bit	>7.1 bit	>7.1 bit	>6.9 bit	>6.9 bit	>6.3 bit	>6.4 bit
ENOB based on SNR (bit)	>7.3 bit	>7.3 bit	>7.3 bit	>7.3 bit	>7.1 bit	>7.1 bit	>7.1 bit	>7.1 bit	>7.0 bit	>7.0 bit	>6.7 bit	>6.7 bit

<b>M4i.221x, M4x.221x, DN2.221 and DN6.221-xx, 8 Bit 1.25 GS/s - standard input ranges</b>												
DC or AC coupled, fixed 50 Ohm												
Test signal frequency												
10 MHz                      40 MHz                      70 MHz                      240 MHz												
Input Range												
±200 mV   ±500 mV   ±1 V   ±2.5 V   ±200 mV   ±1V   ±200 mV   ±1V   ±200 mV   ±1V												
THD (typ) (dB)	<59.0 dB	<58.9 dB	<58.9 dB	<59.0 dB	<53.6 dB	<53.2 dB	<54.4 dB	<54.6 dB	<52.1 dB	<52.4 dB		
SNR (typ) (dB)	>46.9 dB	>47.0 dB	>47.0 dB	>47.0 dB	>46.8 dB	>47.0 dB	>47.0 dB	>47.0 dB	>46.1 dB	>46.2 dB		
SFDR (typ), excl. harm. (dB)	>62.1 dB	>62.1 dB	>62.2 dB	>62.0 dB	>58.2 dB	>59.8 dB	>62.2 dB	>61.9 dB	>59.5 dB	>58.5 dB		
SFDR (typ), incl. harm. (dB)	>60.7 dB	>60.4 dB	>60.5 dB	>60.4 dB	> 56.1 dB	>56.2 dB	> 57.7 dB	>57.6 dB	>52.5 dB	>52.7 dB		
SINAD/THD+N (typ) (dB)	>46.6 dB	>46.7 dB	>46.7 dB	>46.7 dB	>46.0 dB	>46.1 dB	>46.3 dB	>46.3 dB	>45.1 dB	>45.3 dB		
ENOB based on SINAD (bit)	>7.5 bit	>7.5 bit	>7.5 bit	>7.5 bit	>7.4 bit	>7.4 bit	>7.4 bit	>7.4 bit	>7.2 bit	>7.2 bit		
ENOB based on SNR (bit)	>7.5 bit	>7.5 bit	>7.5 bit	>7.5 bit	>7.5 bit	>7.5 bit	>7.5 bit	>7.5 bit	>7.3 bit	>7.4 bit		

<b>M4i.221x, M4x.221x and DN2.221-xx, 8 Bit 1.25 GS/s - low voltage input ranges</b>												
DC or AC coupled, fixed 50 Ohm												
Test signal frequency												
10 MHz                      40 MHz                      70 MHz                      240 MHz												
Input Range												
±40 mV   ±100 mV   ±200 mV   ±500 mV   ±40 mV   ±100 mV   ±40 mV   ±100 mV   ±40 mV   ±100 mV												
THD (typ) (dB)	<57.0 dB	<57.0 dB	<57.1 dB	<57.2 dB								
SNR (typ) (dB)	>44.0 dB	>44.9 dB	>44.9 dB	>44.9 dB								
SFDR (typ), excl. harm. (dB)	>62.1 dB	>62.1 dB	>62.1 dB	>62.2 dB								
SFDR (typ), incl. harm. (dB)	>60.1 dB	>60.2 dB	>60.2 dB	>60.4 dB								
SINAD/THD+N (typ) (dB)	>44.0 dB	>44.8 dB	>44.8 dB	>44.8 dB								
ENOB based on SINAD (bit)	>7.0 bit	>7.2 bit	>7.2 bit	>7.2 bit								
ENOB based on SNR (bit)	>7.0 bit	>7.2 bit	>7.2 bit	>7.2 bit								

Dynamic parameters are measured at ±1 V input range (if no other range is stated) and 50Ω termination with the samplerate specified in the table. Measured parameters are averaged 20 times to get typical values. Test signal is a pure sine wave generated by a signal generator and a matching bandpass filter. Amplitude is >99% of FSR. SNR and RMS noise parameters may differ depending on the quality of the used PC. SNR = Signal to Noise Ratio, THD = Total Harmonic Distortion, SFDR = Spurious Free Dynamic Range, SINAD = Signal Noise and Distortion, ENOB = Effective Number of Bits.



## RMS Noise Level (Zero Noise)

<b>M4i.223x, M4x.223x and DN2.223-xx, DN2.225-xx, DN6.225-xx, 8 Bit 5 GS/s</b>								
Input Range	±200 mV		±500 mV		±1		±2.5 V	
Voltage resolution (1 LSB)	1.6 mV		3.9 mV		7.8 mV		19.5 mV	
DC, fixed 50 Ω, typical	<0.3 LSB	<0.5 mV	<0.3 LSB	<1.2 mV	<0.3 LSB	<2.3 mV	<0.3 LSB	<5.9 mV
DC, fixed 50 Ω, maximum	<0.6 LSB	<0.9 mV	<0.6 LSB	<2.3 mV	<0.5 LSB	<4.7 mV	<0.5 LSB	<11.7 mV

<b>M4i.222x, M4x.222x and DN2.222-xx, 8 Bit 2.5 GS/s</b>								
Input Range	±200 mV		±500 mV		±1		±2.5 V	
Voltage resolution (1 LSB)	1.6 mV		3.9 mV		7.8 mV		19.5 mV	
DC, fixed 50 Ω, typical	<0.3 LSB	<0.5 mV	<0.3 LSB	<1.2 mV	<0.3 LSB	<2.3 mV	<0.3 LSB	<5.9 mV
DC, fixed 50 Ω, maximum	<0.6 LSB	<0.9 mV	<0.7 LSB	<2.7 mV	<0.5 LSB	<4.7 mV	<0.5 LSB	<11.7 mV

<b>Standard Version</b>								
<b>M4i.221x, M4x.221x and DN2.221-xx, 8 Bit 1.25 GS/s</b>								
Input Range	±200 mV		±500 mV		±1		±2.5 V	
Voltage resolution (1 LSB)	1.6 mV		3.9 mV		7.8 mV		19.5 mV	
DC, fixed 50 Ω, typical	<0.2 LSB	<0.3 mV	<0.2 LSB	<0.8 mV	<0.2 LSB	<1.6 mV	<0.2 LSB	<3.9 mV
DC, fixed 50 Ω, maximum	<0.3 LSB	<0.5 mV	<0.3 LSB	<1.2 mV	<0.3 LSB	<2.3 mV	<0.3 LSB	<5.9 mV

<b>Low Voltage Version</b>								
<b>M4i.221x, M4x.221x and DN2.221-xx, 8 Bit 1.25 GS/s</b>								
Input Range	±40 mV		±100 mV		±200 mV		±500 mV	
Voltage resolution (1 LSB)	0.3 mV		0.8 mV		1.6 mV		3.9 mV	
DC, fixed 50 Ω, typical	<0.4 LSB	<0.2 mV	<0.4 LSB	<0.3 mV	<0.4 LSB	<0.6 mV	<0.4 LSB	<1.6 mV
DC, fixed 50 Ω, maximum	<0.5 LSB	<0.2 mV	<0.5 LSB	<0.4 mV	<0.5 LSB	<0.8 mV	<0.5 LSB	<2.0 mV

## DN6 specific Technical Data

### Environmental and Physical Details DN6.xxx

Dimension of Chassis without connectors or bumpers	L x W x H	464 mm x 431 mm x 131 mm
Dimension of Chassis with 19" rack mount option	L x W x H	464 mm x TBD mm x 131 mm (3U height)
Weight (3 internal acquisition/generation modules)		12.1 kg, with rack mount kit: TBD kg
Weight (4 internal acquisition/generation modules)		12.5 kg, with rack mount kit: TBD kg
Weight (5 internal acquisition/generation modules)		12.9 kg, with rack mount kit: TBD kg
Weight (6 internal acquisition/generation modules)		13.4 kg, with rack mount kit: TBD kg
Warm up time		10 minutes
Operating temperature		0°C to 40°C
Storage temperature		-10°C to 70°C
Humidity		10% to 90%
Dimension of packing (single DN6)	L x W x H	580 mm x 580 mm x 280 mm
Volume weight of Packing (single DN6)		19.0 kgs

### Power Consumption

	230 VAC	
12 channel versions	TBD	TBD
16 channel versions	TBD	TBD
20 channel versions	TBD	TBD
24 channel versions	1.09 A	247 W

### MTBF

MTBF	TBD hours
------	-----------

## Block diagram of digitizerNETBOX DN6

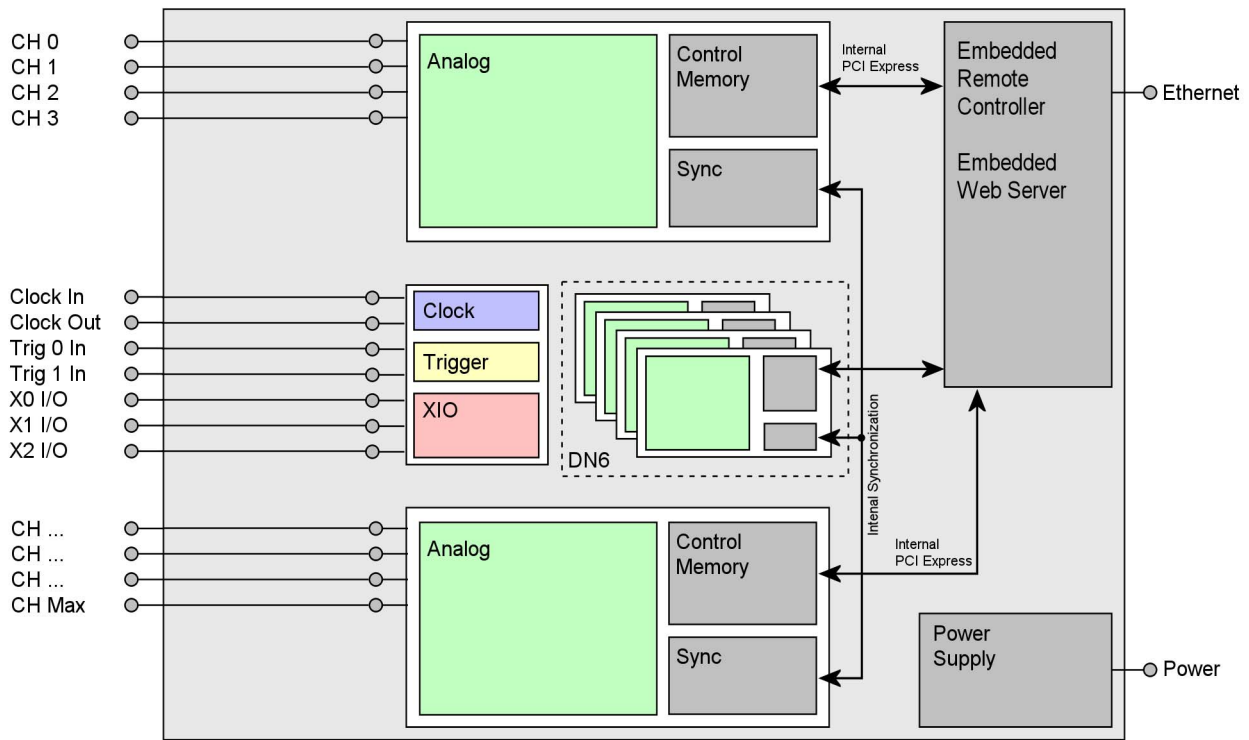

- The number of maximum channels and internal digitizer modules and existence of a synchronization Star-Hub is model dependent.

## Block diagram of digitizerNETBOX module DN6.22x

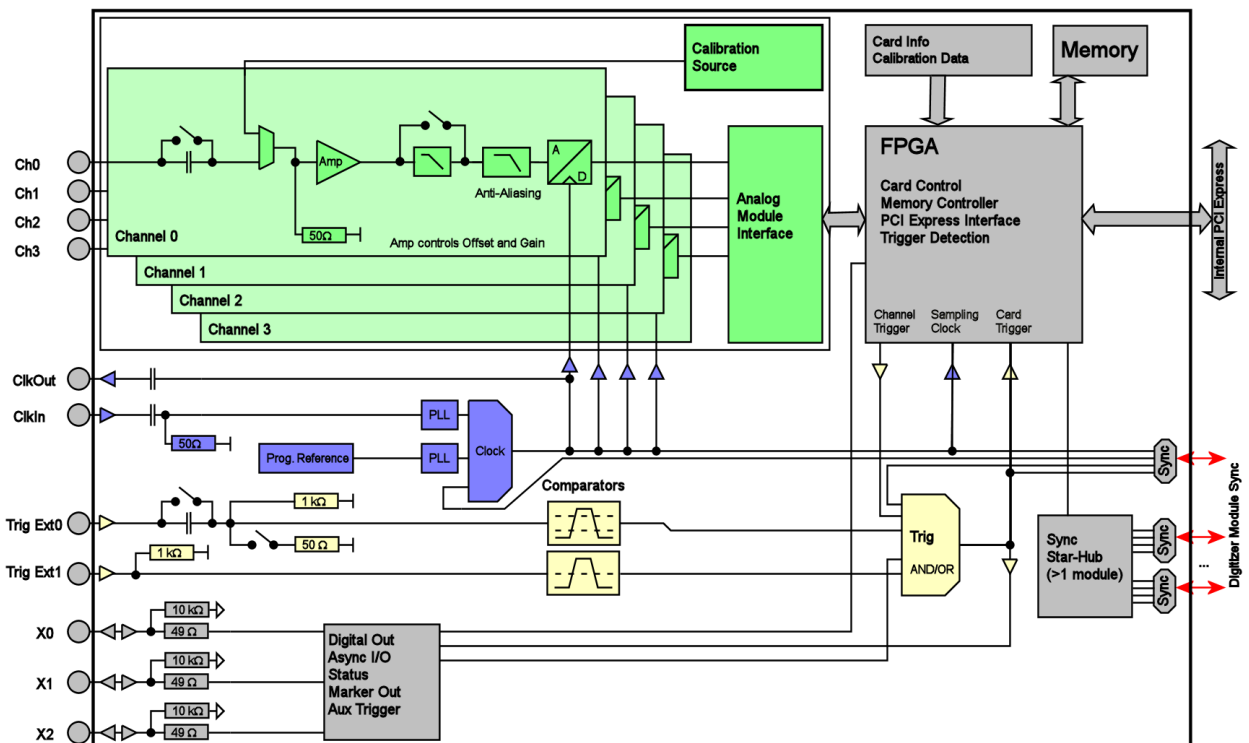

## Order Information

The digitizerNETBOX is equipped with a large internal memory for data storage and supports standard acquisition (Scope), FIFO acquisition (streaming), Multiple Recording, Gated Sampling, ABA mode and Timestamps. Operating system drivers for Windows/Linux 32 bit and 64 bit, drivers and examples for C/C++, IVI (Scope and Digitizer class), LabVIEW (Windows), MATLAB (Windows and Linux), LabWindows/CVI, .NET, Delphi, Java, Python and a Professional license of the oscilloscope software SBench 6 are included.

The system is delivered with a connection cable meeting your countries power connection. Additional power connections with other standards are available as option.

## digitizerNETBOX DN6 - Ethernet/LXI Interface

Order no.	A/D Resolution	Bandwidth	Channels @ Sampling Rate			Installed Memory
DN6.221-12	8 Bit	500 MHz	12 ch @ 1.25 GS/s			3 x 4 GS
DN6.221-16	8 Bit	500 MHz	16 ch @ 1.25 GS/s			4 x 4 GS
DN6.221-20	8 Bit	500 MHz	20 ch @ 1.25 GS/s			5 x 4 GS
DN6.221-24	8 Bit	500 MHz	24 ch @ 1.25 GS/s			6 x 4 GS
DN6.225-12	8 Bit	1.5 GHz	12 ch @ 1.25 GS/s	6 ch @ 2.5 GS/s	3 ch @ 5 GS/s	3 x 4 GS
DN6.225-16	8 Bit	1.5 GHz	16 ch @ 1.25 GS/s	8 ch @ 2.5 GS/s	4 ch @ 5 GS/s	4 x 4 GS
DN6.225-20	8 Bit	1.5 GHz	20 ch @ 1.25 GS/s	10 ch @ 2.5 GS/s	5 ch @ 5 GS/s	5 x 4 GS
DN6.225-24	8 Bit	1.5 GHz	24 ch @ 1.25 GS/s	12 ch @ 2.5 GS/s	6 ch @ 5 GS/s	6 x 4 GS

## Options

Order no.	Option
M4i.22xx-ir40m	Low voltage input range option for 22xx series. 4 Input ranges with $\pm 40$ mV, $\pm 100$ mV, $\pm 200$ mV, $\pm 500$ mV, bandwidth limited. One option is required for each internal digitizer module.

## Options

Order no.	Option
DN6.xxx-Rack	19" rack mounting set for self mounting
DN6.xxx-Emb	Extension to Embedded Server: CPU, more memory, SSD. Access via remote Linux secure shell (ssh)
DN6.xxx-spavg	Signal Processing Firmware Option: Block Average (later installation by firmware - upgrade available)
DN6.xxx-spstat	Signal Processing Firmware Option: Block Statistics/Peak Detect (later installation by firmware - upgrade available)
DN6.xxx-BTPWR	Boot on Power On: the digitizerNETBOX/generatorNETBOX automatically boots if power is switched on.

## Calibration

Order no.	Option
DN6.xxx-Recal	Recalibration of complete digitizerNETBOX/generatorNETBOX DN6 including calibration protocol

## Standard SMA Cables

The standard adapter cables are based on RG174 cables and have a nominal attenuation of 0.3 dB/m at 100 MHz and 0.5 dB/m at 250 MHz. For high speed signals we recommend the low loss cables series CHF.

for Connections	Connection	Length	to BNC male	to BNC female	to SMB female	to MMCX male	to SMA male
All	SMA male	80 cm	Cab-3mA-9m-80	Cab-3mA-9f-80	Cab-3f-3mA-80	Cab-1m-3mA-80	Cab-3mA-3mA-80
All	SMA male	200 cm	Cab-3mA-9m-200	Cab-3mA-9f-200	Cab-3f-3mA-200	Cab-1m-3mA-200	Cab-3mA-3mA-200
Probes (short)	SMA male	5 cm		Cab-3mA-9f-5			

## Low Loss SMA Cables

The low loss adapter cables are based on MF141 cables and have an attenuation of 0.3 dB/m at 500 MHz and 0.5 dB/m at 1.5 GHz. They are recommended for signal frequencies of 200 MHz and above.

Order no.	Option
CHF-3mA-3mA-200	Low loss cables SMA male to SMA male 200 cm
CHF-3mA-9m-200	Low loss cables SMA male to BNC male 200 cm

### Technical changes and printing errors possible

SBench, digitizerNETBOX and generatorNETBOX are registered trademarks of Spectrum Instrumentation GmbH. Microsoft, Visual C++, Windows, Windows 98, Windows NT, Window 2000, Windows XP, Windows Vista, Windows 7, Windows 8 and Windows 10 are trademarks/registered trademarks of Microsoft Corporation. LabVIEW, DASYLab, Diadem and LabWindows/CVI are trademarks/registered trademarks of National Instruments Corporation. MATLAB is a trademark/registered trademark of The Mathworks, Inc. Delphi and C++Builder are trademarks/registered trademarks of Embarcadero Technologies, Inc. Keysight VEE, VEE Pro and VEE OneLab are trademarks/registered trademarks of Keysight Technologies, Inc. FlexPro is a registered trademark of Weisang GmbH & Co. KG. PCIe, PCI Express and PCI-X and PCI-SIG are trademarks of PCI-SIG. LXI is a registered trademark of the LXI Consortium. PICMG and CompactPCI are trademarks of the PCI Industrial Computation Manufacturers Group. Oracle and Java are registered trademarks of Oracle and/or its affiliates. Intel and Intel Core i3, Core i5, Core i7, Core i9 and Xeon are trademarks and/or registered trademarks of Intel Corporation. AMD, Opteron, Sempron, Phenom, FX, Ryzen and EPYC are trademarks and/or registered trademarks of Advanced Micro Devices. NVIDIA, CUDA, GeForce, Quadro and Tesla are trademarks/registered trademarks of NVIDIA Corporation.