

M2p.59xx-x4 - 16 bit general purpose Digitizer

- Up to 125 MS/s on four or 80 MS/s on eight channels
- Ultra Fast PCI Express x4 interface
- Simultaneously sampling on all channels
- Separate dedicated 16 bit ADC and amplifier per channel
- 6 input ranges: ± 200 mV up to ± 10 V
- 512 MSamples (1 GByte) on-board memory
- Window, re-arm, OR/AND trigger
- Synchronization of up to 16 cards per system
- Features: Single-Shot, Streaming, Multiple Recording, Gated Sampling, ABA, Timestamps
- Direct data transfer to CUDA GPU using SCAPP option

Speed	SNR	ENOB
5 MS/s	up to 86.0 dB	up to 14.0 LSB
20 MS/s	up to 81.0 dB	up to 13.2 LSB
40 MS/s	up to 75.3 dB	up to 12.2 LSB
80 MS/s	up to 74.2 dB	up to 12.0 LSB
125 MS/s	up to 73.3 dB	up to 11.8 LSB

SCAPP
Spectrum's CUDA Access - Parallel Processing

M2p
series

- PCIe x4 Gen 1 Interface
- Works with x4/x8/x16* PCIe slots
- Sustained streaming mode up to 700 MB/s**
- Half-length PCIe Form Factor

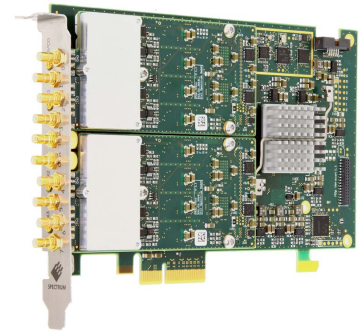

Operating Systems	Recommended Software	Drivers
<ul style="list-style-type: none"> • Windows 7 (SP1), 8, 10, Server 2008 R2 and newer • Linux Kernel 2.6, 3.x, 4.x, 5.x • Windows/Linux 32 and 64 bit 	<ul style="list-style-type: none"> • Visual C++, Delphi, C++ Builder, GNU C++, VB.NET, C#, J#, Java, Python • SBench 6 	<ul style="list-style-type: none"> • MATLAB • LabVIEW • LabWindows/CVI • IVI

Model	single-ended channels				true differential channels (non-isolated)		
	1 ch	2 ch	4 ch	8 ch	1 ch	2 ch	4 ch
M2p.5911-x4	5 MS/s	5 MS/s			5 MS/s	5 MS/s	
M2p.5912-x4	5 MS/s	5 MS/s	5 MS/s		5 MS/s	5 MS/s	
M2p.5916-x4	5 MS/s	5 MS/s	5 MS/s		5 MS/s	5 MS/s	5 MS/s
M2p.5913-x4	5 MS/s	5 MS/s	5 MS/s	5 MS/s	5 MS/s	5 MS/s	5 MS/s
M2p.5920-x4	20 MS/s	(OEM version)			20 MS/s	(OEM version)	
M2p.5921-x4	20 MS/s	20 MS/s			20 MS/s	20 MS/s	
M2p.5922-x4	20 MS/s	20 MS/s	20 MS/s		20 MS/s	20 MS/s	
M2p.5926-x4	20 MS/s	20 MS/s	20 MS/s		20 MS/s	20 MS/s	20 MS/s
M2p.5923-x4	20 MS/s	20 MS/s	20 MS/s	20 MS/s	20 MS/s	20 MS/s	20 MS/s
M2p.5930-x4	40 MS/s	(OEM version)			40 MS/s	(OEM version)	
M2p.5931-x4	40 MS/s	40 MS/s			40 MS/s	40 MS/s	
M2p.5932-x4	40 MS/s	40 MS/s	40 MS/s		40 MS/s	40 MS/s	
M2p.5936-x4	40 MS/s	40 MS/s	40 MS/s		40 MS/s	40 MS/s	40 MS/s
M2p.5933-x4	40 MS/s	40 MS/s	40 MS/s	40 MS/s	40 MS/s	40 MS/s	40 MS/s
M2p.5940-x4	80 MS/s				80 MS/s		
M2p.5941-x4	80 MS/s	80 MS/s			80 MS/s	80 MS/s	
M2p.5942-x4	80 MS/s	80 MS/s	80 MS/s		80 MS/s	80 MS/s	
M2p.5946-x4	80 MS/s	80 MS/s	80 MS/s		80 MS/s	80 MS/s	80 MS/s
M2p.5943-x4	80 MS/s	80 MS/s	80 MS/s	80 MS/s	80 MS/s	80 MS/s	80 MS/s
M2p.5960-x4	125 MS/s				125 MS/s		
M2p.5961-x4	125 MS/s	125 MS/s			125 MS/s	125 MS/s	
M2p.5962-x4	125 MS/s	125 MS/s	125 MS/s		125 MS/s	125 MS/s	
M2p.5966-x4	125 MS/s	125 MS/s	125 MS/s		125 MS/s	125 MS/s	125 MS/s
M2p.5968-x4	125 MS/s	125 MS/s	125 MS/s	80 MS/s	125 MS/s	125 MS/s	125 MS/s

General Information

The M2p.59xx series allows recording of up to eight Single-Ended channels or up to four differential channels both with sampling rates of up to 125 MS/s. These PCI Express cards offer outstanding A/D features both in resolution and speed. The cards can be switched between Single-Ended inputs with a programmable offset and true differential inputs. If used in differential mode each two inputs are connected together reducing the number of available channels by half. Importantly, the high-resolution 16-bit ADCs deliver sixteen times more resolution than digitizers using older 12-bit technology and 256 times more resolution than what is available from digital scopes that commonly use 8-bit ADCs. All boards of the M2p.59xx series may use the whole installed on-board memory of up to 512 MSamples, completely for the currently activated number of channels.

*Some x16 PCIe slots are for the use of graphic cards only and can't be used for other cards. **Throughput measured with a motherboard chipset supporting a TLP size of 256 bytes.

Software Support

Windows drivers

The cards are delivered with drivers for Windows 7, Windows 8 and Windows 10 (each 32 bit and 64 bit). Programming examples for Visual C++, C++ Builder, LabWindows/CVI, Delphi, Visual Basic, VB.NET, C#, J#, Python, Java and IVI are included.

Linux Drivers



All cards are delivered with full Linux support. Pre compiled kernel modules are included for the most common distributions like Fedora, Suse, Ubuntu LTS or Debian. The Linux support includes SMP systems, 32 bit and 64 bit systems, versatile programming examples for GNU C++, Python as well as the possibility to get the driver sources for your own compilation.

SBench 6

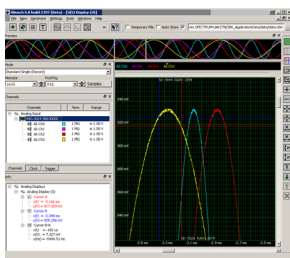

A base license of SBench 6, the easy-to-use graphical operating software for Spectrum cards, is included in the delivery. The base license makes it possible to test the card, display acquired data and make some basic measurements. It's a valuable tool for checking the card's performance and assisting with the unit's initial

setup. The cards also come with a demo license for the SBench 6 professional version. This license gives the user the opportunity to test the additional features of the professional version with their hardware. The professional version contains several advanced measurement functions, such as FFTs and X/Y display, import and export utilities as well as support for all acquisition modes including data streaming. Data streaming allows the cards to continuously acquire data and transfer it directly to the PC RAM or hard disk. SBench 6 has been optimized to handle data files of several GBytes. SBench 6 runs under Windows as well as Linux (KDE, GNOME and Unity) operating systems. A test version of SBench 6 can be downloaded directly over the internet and can run the professional version in a simulation mode without any hardware installed. Existing customers can also request a demo license for the professional version from Spectrum. More details on SBench 6 can be found in the SBench 6 data sheet.

Third-party products

Spectrum supports the most popular third-party software products such as LabVIEW, MATLAB or LabWindows/CVI. All drivers come with detailed documentation and working examples are included in the delivery. Support for other software packages, like VEE or DasyLab, can also be provided on request.

SCAPP - CUDA GPU based data processing

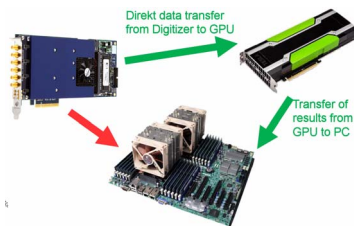

For applications requiring high powered signal and data processing Spectrum offers SCAPP (Spectrum's CUDA Access for Parallel Processing). The SCAPP SDK allows a direct link between Spectrum digitizers, AWGs or Digital Data Acquisition Cards

and CUDA based GPU cards. Once in the GPU users can harness the processing power of the GPU's multiple (up to 5000) processing cores and large (up to 24 GB) memories. SCAPP uses an RDMA (Linux only) process to send data at the full PCIe transfer speed to and from the GPU card. The SDK includes a set of examples for interaction between the Spectrum card and the GPU card and another set of CUDA parallel processing examples with easy building

blocks for basic functions like filtering, averaging, data de-multiplexing, data conversion or FFT. All the software is based on C/C++ and can easily be implemented, expanded and modified with normal programming skills.

Hardware features and options

PCI Express x4

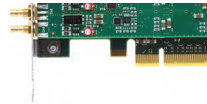

The M2p series cards use a PCI Express x4 Gen 1 connection. They can be used in PCI Express x4, x8 and x16 slots with hosts supporting Gen 1, Gen 2 or Gen 3.

The maximum sustained data transfer rate is more than 700 MByte/s (read direction) or 700 MByte/s (write direction) per slot. Physically supported slots that are electrically connected with only x1 or x2 can also be used with the M2p series cards, but with reduced data transfer rates.

Connections

The cards are equipped with SMB connectors for the analog signals as well as for the external trigger and clock input. In addition, there are four MMCX connectors: one multi-function output (X0) and three multi-function I/O connectors (X1, X2, X3). These multi-function connectors can be individually programmed to perform different functions:



- Clock output (X0 only)
- Trigger output
- Status output (armed, triggered, ready, ...)
- Synchronous digital inputs, being stored inside the analog data samples
- Asynchronous I/O lines
- Logic trigger inputs

Input Amplifier

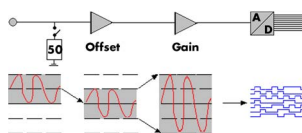

The analog inputs can be adapted to real world signals using a wide variety of settings that are individual for each channel. By using software commands the input termination can be changed

between 50 Ohm and 1 MOhm, one can select a matching input range and the signal offset can be compensated for.

Differential inputs

With a simple software command the inputs can individually be switched from single-ended (in relation to ground) to differential by combining each two single-ended inputs to one differential input. When the inputs are used in differential mode the A/D converter measures the difference between two lines with relation to system ground.

Automatic on-board calibration

All of the channels are calibrated in factory before the board is shipped. To compensate for different variations like PC power supply, temperature and aging, the software driver provides routines for an automatic onboard offset and gain calibration of all input ranges. All the cards contain a high precision on-board calibration reference.

Digital inputs

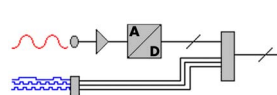

This option acquires additional synchronous digital channels phase-stable with the analog data. As default a maximum of 3 additional digital inputs are available on the front plate of the card using the multi-purpose I/O lines. An additional option offers 16 more digital channels.

Ring buffer mode

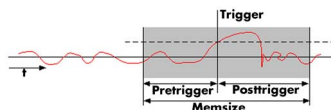

The ring buffer mode is the standard mode of all oscilloscope instruments. Digitized data is continuously written into a ring memory until a trigger event is detected. After the trigger, post-trigger samples are recorded and pre-trigger samples can also be stored. The number of pre-trigger samples available simply equals the total ring memory size minus the number of post trigger samples.

FIFO mode

The FIFO or streaming mode is designed for continuous data transfer between the card and the PC memory. When mounted in a PCI Express x4 Gen 1 interface read streaming speeds of up to 700 MByte/s are possible. The control of the data stream is done automatically by the driver on interrupt request basis. The complete installed onboard memory is used to buffer the data, making the continuous streaming process extremely reliable.

Channel trigger

The digitizers offer a wide variety of trigger modes. These include a standard triggering mode based on a signals level and slope, like that found in most oscilloscopes. It is also possible to define a window mode, with two trigger levels, that enables triggering when signals enter or exit the window. Each input has its own trigger circuit which can be used to setup conditional triggers based on logical AND/OR patterns. All trigger modes can be combined with a re-arming mode for accurate trigger recognition even on noisy signals.

External trigger input

All boards can be triggered using an external analog or digital signal. The external trigger input has one comparator that can be used for standard edge and level triggers.

Multiple Recording

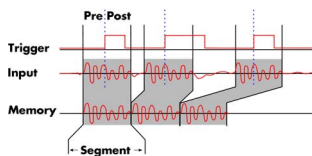

The Multiple Recording mode allows the recording of several trigger events with an extremely short re-arming time. The hardware doesn't need to be restarted in between. The on-board memory is divided in several segments of the same size. Each of them is filled with data if a trigger event occurs. Pre- and posttrigger of the segments can be programmed. The number of acquired segments is only limited by the used memory and is unlimited when using FIFO mode.

Gated Sampling

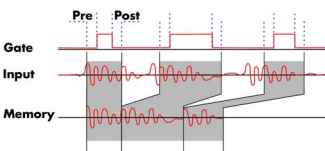

The Gated Sampling mode allows data recording controlled by an external gate signal. Data is only recorded if the gate signal has a programmed level. In addition a pre-area before start of the gate signal as well as a post area after end of the gate signal can be acquired. The number of gate segments is only limited by the used memory and is unlimited when using FIFO mode.

ABA mode

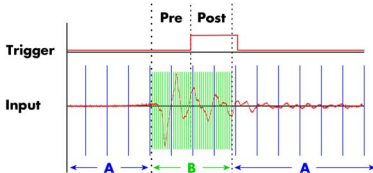

The ABA mode combines slow continuous data recording with fast acquisition on trigger events. The ABA mode works like a slow data logger combined with a

fast digitizer. The exact position of the trigger events is stored as timestamps in an extra memory.

Timestamp

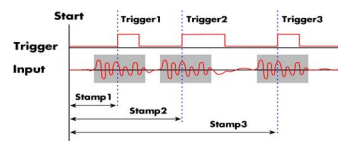

The timestamp function writes the time positions of the trigger events in an extra memory. The timestamps are relative to the start of recording, a defined zero time, externally synchronized to a radio clock, an IRIG-B or a GPS receiver.

Using the external synchronization gives a precise time relation for acquisitions of systems on different locations.

External clock input and output

Using a dedicated connector a sampling clock can be fed in from an external system. Additionally it's also possible to output the internally used sampling clock on a separate connector to synchronize external equipment to this clock.

Reference clock

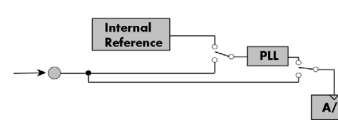

The option to use a precise external reference clock (typically 10 MHz) is necessary to synchronize the instrument for high-quality measurements with external equipment (like a signal source). It's also possible to enhance the stability of the sampling clock in this way. The driver automatically generates the requested sampling clock from the fed in reference clock.

Star-Hub



The Star-Hub is an additional module allowing the phase stable synchronization of up to 16 boards in one system. Two versions are available: one with up to 6 cards and the large version supports up to 16 cards in one system. Both versions can be mounted in two different ways, to either extend the cards

length to $\frac{3}{4}$ PCIe length occupying one slot, or extend its width to two slots whilst keeping the $\frac{1}{2}$ PCIe length.



Independent of the number of boards there is no phase delay between the channels. The Star-Hub distributes trigger and clock information between all boards. As a result all connected boards are running with the same clock and the same trigger. All trigger sources can be combined with OR/AND. For digitizers that means all channels of all cards to be trigger source at the same time.

Multi-Purpose I/O 4 Standard + 16 Option



As standard each card has 4 multi-purpose I/O lines (3 x I/O and 1 x Output). As an option a piggy-back module carries additional 16 multi-purpose I/O lines making up to 19 digital inputs or 20 digital outputs.

This option is available with SMB connectors or with FX/2 connector for flat-ribbon cable, with pin-compatibility with previous hardware versions.

All I/O lines can be used for synchronous digital data acquisition (digitizer), synchronous digital data output/marker output (AWG), asynchronous digital I/O, can carry additional status information or can be used as trigger inputs

External Amplifiers



For the acquisition of extremely small voltage levels with a high bandwidth a series of external amplifiers is available. Each of the one channel amplifiers is working with a fixed input impedance and allows - depending on the bandwidth - to select different amplification levels between x10 (20 dB) up to x1000 (60 dB). Using the external amplifiers of the SPA series voltage levels in the μV and mV area can be acquired.

Using the external amplifiers of the SPA series voltage levels in the μV and mV area can be acquired.

Technical Data

Analog Inputs

Resolution		16 bit (can be reduced to acquire simultaneous digital inputs)
Input Range	software programmable	$\pm 200 \text{ mV}$, $\pm 500 \text{ mV}$, $\pm 1 \text{ V}$, $\pm 2 \text{ V}$, $\pm 5 \text{ V}$, $\pm 10 \text{ V}$
Input Type	software programmable	Single-ended or True Differential
Input Offset (single-ended)	software programmable	programmable to $\pm 100\%$ of input range in steps of 1%
ADC Differential non linearity (DNL)	ADC only	591x: $\pm 0.2/\pm 0.8 \text{ LSB (typ./max.)}$ 592x: $\pm 0.2/\pm 0.8 \text{ LSB (typ./max.)}$ 593x: $\pm 0.5/\pm 0.9 \text{ LSB (typ./max.)}$ 594x: $\pm 0.5/\pm 0.9 \text{ LSB (typ./max.)}$ 596x: $\pm 0.5/\pm 0.9 \text{ LSB (typ./max.)}$
ADC Integral non linearity (INL)	ADC only	591x: $\pm 1.0/\pm 2.3 \text{ LSB (typ./max.)}$ 592x: $\pm 1.0/\pm 2.3 \text{ LSB (typ./max.)}$ 593x: $\pm 2.0/\pm 7.5 \text{ LSB (typ./max.)}$ 594x: $\pm 2.0/\pm 7.5 \text{ LSB (typ./max.)}$ 596x: $\pm 2.0/\pm 7.5 \text{ LSB (typ./max.)}$
Offset error (full speed), DC signal	after warm-up and calibration	$\leq 0.1\%$ of range
Gain error (full speed), DC signal	after warm-up and calibration	$\leq 0.1\%$ of reading
AC accuracy	1 kHz signal	$\leq 0.3\%$ of reading
AC accuracy	50 kHz signal	$\leq 0.5\%$ of reading
Crosstalk: Signal 1 MHz, 50 Ω	range $\leq \pm 1\text{V}$ range $\geq \pm 2\text{V}$	$\leq 95 \text{ dB}$ on adjacent channels $\leq 90 \text{ dB}$ on adjacent channels
Crosstalk: Signal 10 MHz, 50 Ω	range $\leq \pm 1\text{V}$ range $\geq \pm 2\text{V}$	$\leq 87 \text{ dB}$ on adjacent channels $\leq 85 \text{ dB}$ on adjacent channels
Analog Input impedance	software programmable	50 Ω / 1 M Ω 30 pF
Analog input coupling	fixed	DC
Over voltage protection	range $\leq \pm 1\text{V}$	$\pm 5 \text{ V}$ (1 M Ω), 3.5 Vrms (50 Ω)
Over voltage protection	range $\geq \pm 2\text{V}$	$\pm 50 \text{ V}$ (1 M Ω), 5 Vrms (50 Ω)
CMRR (Common Mode Rejection Ratio)	range $\leq \pm 1\text{V}$	100 kHz: 75 dB, 1 MHz: 60 dB, 10 MHz: 40 dB
CMRR (Common Mode Rejection Ratio)	range $\geq \pm 2\text{V}$	100 kHz: 55 dB, 1 MHz: 52 dB, 10 MHz: 50 dB
Channel selection (single-ended inputs)	software programmable	1, 2, 4 or 8 channels (maximum is model dependent)
Channel selection (true differential inputs)	software programmable	1, 2 or 4 channels (maximum is model dependent)

Trigger

Available trigger modes	software programmable	Channel Trigger, External, Software, Window, Pulse, Re-Arm, Spike, Or/And, Delay
Channel trigger level resolution	software programmable	16 bit
Trigger edge	software programmable	Rising edge, falling edge or both edges
Trigger pulse width	software programmable	0 to [4G - 1] samples in steps of 1 sample
Trigger delay	software programmable	0 to [4G - 1] samples in steps of 1 samples
Trigger holdoff (for Multi, ABA, Gate)	software programmable	0 to [4G - 1] samples in steps of 1 samples
Multi, ABA, Gate: re-arming time		< 40 samples (+ programmed pretrigger + programmed holdoff)
Pretrigger at Multi, ABA, Gate, FIFO	software programmable	8 up to [32 kSamples / number of active channels] in steps of 8
Posttrigger	software programmable	8 up to [8G - 4] samples in steps of 8 (defining pretrigger in standard scope mode)
Memory depth	software programmable	8 up to [installed memory / number of active channels] samples in steps of 8
Multiple Recording/ABA segment size	software programmable	8 up to [installed memory / number of active channels] samples in steps of 8
Internal/External trigger accuracy		1 sample
Timestamp modes	software programmable	Standard, Startreset, external reference clock on X1 (e.g. PPS from GPS, IRIG-B)
Data format		Std., Startreset: 64 bit counter, increments with sample clock (reset manually or on start) RefClock: 24 bit upper counter (increment with RefClock) 40 bit lower counter (increments with sample clock, reset with RefClock)
Extra data	software programmable	none, acquisition of X1/X2/X3 inputs at trigger time, trigger source (for OR trigger)
Size per stamp		128 bit = 16 bytes
External trigger		Ext
External trigger type		Single level comparator
External trigger impedance	software programmable	50 Ω / 5 kΩ
External trigger input level		±5 V (5 kΩ), ±2.5 V (50 Ω), ±20 V (5 kΩ), 5 Vrms (50 Ω)
External trigger over voltage protection		200 mVpp
External trigger sensitivity (minimum required signal swing)		
External trigger level	software programmable	±5 V in steps of 1 mV
External trigger bandwidth	50 Ω 5 kΩ	DC to 400 MHz DC to 300 MHz
Minimum external trigger pulse width		≥ 2 samples
		X1, X2, X3
		3.3V LVTTTL logic inputs For electrical specifications refer to „Multi Purpose I/O lines“ section.
		n.a. DC to 125 MHz
		≥ 2 samples

Multi Purpose I/O lines

Number of multi purpose output lines		one, named X0
Number of multi purpose input/output lines		three, named X1, X2, X3
Multi Purpose line		X0
Input: available signal types	software programmable	n.a.
Input: signal levels		n.a.
Input: impedance		n.a.
Input: maximum voltage level		n.a.
Input: maximum bandwidth		n.a.
Output: available signal types	software programmable	Run-, Arm-, Trigger-Output, Asynchronous Digital-Out, ADC Clock Output,
Output: impedance		50 Ω
Output: drive strength		Capable of driving 50 Ω loads, maximum drive strength ±48 mA
Output: type / signal levels		3.3V LVTTTL, TTL compatible for high impedance loads
Output: update rate (synchronous modes)		sampling clock
		X1, X2, X3
		Synchronous Digital-In, Asynchronous Digital-In, Timestamp Reference Clock, Logic trigger
		3.3 V LVTTTL
		10 kΩ to 3.3 V
		-0.5 V to +4.0 V
		125 MHz
		Run-, Arm-, Trigger-Output, Asynchronous Digital-Out

Option M2p.xxxx-DigFX2

Number of additional multi-purpose I/O lines		16
Multi Purpose functionality	software programmable	Same functions as standard multi-purpose lines (see above)
Card width with installed option		2 slots
Connector		1 x Hirose FX/2 (one adapter cable to IDC connector included) 4 x SMB male, selectable by manual jumper
Compatibility		Pinning compatible with M2i.xxxx-dig option and M2i.70xx connectors

Option M2p.xxxx-DigSMB

Number of additional multi purpose I/O lines		16
Multi Purpose functionality	software programmable	Same functions as standard multi-purpose lines (see above)
Card width with installed option		2 slots
Connectors on bracket		10 x SMB male
Internal connectors		6 x SMB male

Clock

Clock Modes	software programmable	internal PLL, external clock, external reference clock, sync
Internal clock range (PLL mode)	software programmable	see „Clock Limitations and Bandwidth“ table below
Internal clock accuracy	after warm-up	$\leq \pm 1.0$ ppm (at time of calibration in production)
Internal clock aging		$\leq \pm 0.5$ ppm / year
PLL clock setup granularity (int. or ext. reference)		1 Hz
External reference clock range	software programmable	128 kHz up to 125 MHz
Direct external clock to internal clock delay		4.3 ns
Direct external clock range		see „Clock Limitations and Bandwidth“ table below
External clock type		Single level comparator
External clock input level		± 5 V (5 k Ω), ± 2.5 V (50 Ω),
External clock input impedance	software programmable	50 Ω / 5 k Ω
External clock over voltage protection		± 20 V (5 k Ω), 5 Vrms (50 Ω)
External clock sensitivity (minimum required signal swing)		200 mVpp
External clock level	software programmable	± 5 V in steps of 1 mV
External clock edge		rising edge used
External reference clock input duty cycle		45% - 55%
Clock output electrical specification		Available via Multi Purpose output X0. Refer to „Multi Purpose I/O lines“ section.
Synchronization clock multiplier „N“ for different clocks on synchronized cards	software programmable	N being a multiplier (1, 2, 3, 4, 5, ... Max) of the card with the currently slowest sampling clock. The card maximum (see „Clock Limitations and Bandwidth“ table below) must not be exceeded.
ABA mode clock divider for slow clock	software programmable	8 up to (64k - 8) in steps of 8
Channel to channel skew on one card		< 200 ps (typical)
Skew between star-hub synchronized cards		TBD

Connectors

Analog		SMB male (one for each single-ended input/output)	Cable-Type: Cab-3f-xx-xx
Trigger Input		SMB male	Cable-Type: Cab-3f-xx-xx
Clock Input		SMB male	Cable-Type: Cab-3f-xx-xx
Standard Multi Purpose I/O		MMCX female (4 lines)	Cable-Type: Cab-1m-xx-xx
Option M2p.xxxx-DigSMB	on extra bracket	SMB male	Cable-Type: Cab-3f-xx-xx
Option M2p.xxxx-DigFX2	on extra bracket	40-pole half pitch (Hirose FX2)	Cable-Type: Cab-d40-xx-xx

Environmental and Physical Details

Dimension (Single Card M2p.65x3 or 65x8)	8 channel AWG	168 mm (½ PCIe length) x 107 mm x 30 mm (double slot width)
Dimension (all other single cards)		168 mm (½ PCIe length) x 107 mm x 20 mm (single slot width)
Dimension (Card with -SH6tm or -SH16tm installed)		168 mm (½ PCIe length) x 107 mm x 40 mm (double slot width)
Dimension (Card with -SH6ex or -SH16ex installed)		245 mm (¾ PCIe length) x 107 mm x 20 mm (single slot width)
Weight (M2p.59xx series)	maximum	215 g
Weight (M2p.65x0, M2p.65x1, M2p.65x6 series)	maximum	195 g
Weight (M2p.65x3, M2p.65x8 series)	maximum	305 g
Weight (Star-Hub Option -SH6ex, -SH6tm)	including 6 sync cables	65 g
Weight (Star-Hub Option -SH16ex, -SH16tm)	including 16 sync cables	90 g
Warm up time		10 minutes
Operating temperature		0 °C to 40 °C
Storage temperature		-10 °C to 70 °C
Humidity		10% to 90%

PCI Express specific details

PCIe slot type	x4, Generation 1
PCIe slot compatibility (physical)	x4, x8, x16
PCIe slot compatibility (electrical)	x1, x4, x8, x16, Generation 1, Generation 2, Generation 3
Sustained streaming mode (Card-to-System: M2p.59xx)	> 700 MB/s (measured with a chipset supporting a TLP size of 256 bytes, using PCIe x4 Gen1)
Sustained streaming mode (System-to-Card: M2p.65xx)	> 700 MB/s (measured with a chipset supporting a TLP size of 256 bytes, using PCIe x4 Gen1)

Certification, Compliance, Warranty

EMC Immunity	Compliant with CE Mark
EMC Emission	Compliant with CE Mark
Product warranty	5 years starting with the day of delivery
Software and firmware updates	Life-time, free of charge

Power Consumption

	3.3V	12V	Total
M2p.59x0, 59x1, 59x2	0.1 A	1.1 A	13.6 W
M2p.59x3, 59x6, 59x8	0.1 A	1.5 A	18.4 W

MTBF

MTBF	TBD hours
------	-----------

Clock Limitations and Bandwidth

	M2p.591x, DN2.591-xx DN6.591-xx	M2p.592x, DN2.592-xx DN6.592-xx	M2p.593x, DN2.593-xx DN6.593-xx	M2p.594x	M2p.596x, DN2.596-xx DN6.596-xx
max internal clock (non-synchronized cards)	5 MS/s	20 MS/s	40 MS/s	80 MS/s	125 MS/s
min internal clock (non-synchronized cards)	1 kS/s	1 kS/s	1 kS/s	1 kS/s	1 kS/s
max internal clock (cards synchronized via star-hub)	5 MS/s	20 MS/s	40 MS/s	80 MS/s	125 MS/s
min internal clock (cards synchronized via star-hub)	128 kS/s	128 kS/s	128 kS/s	128 kS/s	128 kS/s
max direct external clock	5 MS/s	20 MS/s	40 MS/s	80 MS/s	125 MS/s
min direct external clock	1 MS/s	1 MS/s	1 MS/s	1 MS/s	1 MS/s
-3 dB analog input bandwidth	> 2.0 MHz	> 10 MHz	> 20 MHz	> 40 MHz	> 60 MHz
-3 dB analog input bandwidth, digital filter active deactivated	> 2.5 MHz	n.a.	n.a.	n.a.	n.a.

RMS Noise Level (Zero Noise), typical figures

M2p.591x, DN2.591-xx, DN6.591-xx digital filtering active												
Input Range	±200 mV		±500 mV		±1	±2 V	±5 V	±10 V				
Voltage resolution	6.1 μV		15.3 μV		30.5 μV	61.0 μV	152.6 μV	305.2 μV				
50 Ω	<1.5 LSB	<10 μV	<1.2 LSB	<19 μV	<1.0 LSB	<31 μV	<3.0 LSB	<183 μV	<1.6 LSB	<245 μV	<1.2 LSB	<367 μV
1 MΩ	<1.5 LSB	<10 μV	<1.2 LSB	<19 μV	<1.0 LSB	<31 μV	<3.0 LSB	<183 μV	<1.6 LSB	<245 μV	<1.2 LSB	<367 μV

M2p.592x, DN2.592-xx, DN6.592-xx												
Input Range	±200 mV		±500 mV		±1	±2 V	±5 V	±10 V				
Voltage resolution	6.1 μV		15.3 μV		30.5 μV	61.0 μV	152.6 μV	305.2 μV				
50 Ω	<4.0 LSB	<25 μV	<2.6 LSB	<40 μV	<2.1 LSB	<65 μV	<4.3 LSB	<263 μV	<2.6 LSB	<397 μV	<2.1 LSB	<641 μV
1 MΩ	<4.5 LSB	<28 μV	<3.0 LSB	<46 μV	<2.5 LSB	<107 μV	<4.5 LSB	<275 μV	<3.0 LSB	<458 μV	<2.5 LSB	<763 μV

M2p.593x, DN2.593-xx, DN6.593-xx												
Input Range	±200 mV		±500 mV		±1	±2 V	±5 V	±10 V				
Voltage resolution	6.1 μV		15.3 μV		30.5 μV	61.0 μV	152.6 μV	305.2 μV				
50 Ω	<6.0 LSB	<37 μV	<5.0 LSB	<77 μV	<4.5 LSB	<138 μV	<6.5 LSB	<397 μV	<5.0 LSB	<763 μV	<4.5 LSB	<1.4 mV
1 MΩ	<6.5 LSB	<40 μV	<5.0 LSB	<77 μV	<4.5 LSB	<138 μV	<6.5 LSB	<397 μV	<5.0 LSB	<763 μV	<4.5 LSB	<1.4 mV

M2p.594x												
Input Range	±200 mV		±500 mV		±1	±2 V	±5 V	±10 V				
Voltage resolution	6.1 μV		15.3 μV		30.5 μV	61.0 μV	152.6 μV	305.2 μV				
50 Ω	<7.0 LSB	<43 μV	<5.5 LSB	<85 μV	<4.5 LSB	<138 μV	<7.5 LSB	<458 μV	<5.5 LSB	<840 μV	<4.5 LSB	<1.4 mV
1 MΩ	<7.5 LSB	<46 μV	<5.8 LSB	<89 μV	<4.5 LSB	<138 μV	<7.7 LSB	<470 μV	<5.8 LSB	<886 μV	<4.5 LSB	<1.4 mV

M2p.596x, DN2.596-xx, DN6.596-xx												
Input Range	±200 mV		±500 mV		±1	±2 V	±5 V	±10 V				
Voltage resolution	6.1 μV		15.3 μV		30.5 μV	61.0 μV	152.6 μV	305.2 μV				
50 Ω	<9.0 LSB	<55 μV	<6.8 LSB	<104 μV	<5.5 LSB	<168 μV	<9.0 LSB	<550 μV	<6.8 LSB	<1.1 mV	<5.5 LSB	<1.7 mV
1 MΩ	<9.5 LSB	<58 μV	<7.1 LSB	<109 μV	<5.5 LSB	<168 μV	<9.5 LSB	<580 μV	<7.1 LSB	<1.1 mV	<5.5 LSB	<1.7 mV

Dynamic Parameters, typical figures

M2p.591x, DN2.591-xx, DN6.591-xx digital filtering active								
Test - sampling rate	5 MS/s							
Input Range	±200 mV		±500 mV		±1	±2 V		
Test Signal Frequency	20 kHz	1 MHz	20 kHz	1 MHz	20 kHz	1 MHz	20 kHz	1 MHz
SNR (typ)	≥ 83.5 dB	≥ 82.8 dB	≥ 85.0 dB	≥ 84.9 dB	≥ 86.2 dB	≥ 85.7 dB	n.a.	n.a.
THD (typ)	(≤ 84.4 dB)	≤ -93.5 dB	(≤ 86.3 dB)	≤ -93.1 dB	(≤ 86.9 dB)	≤ -91.8 dB	n.a.	n.a.
SFDR (typ), excl. harm.	≥ 103.0 dB	≥ 103.0 dB	≥ 104.0 dB	≥ 107.0 dB	≥ 103.0 dB	≥ 107.0 dB	n.a.	n.a.
ENOB (based on SNR)	≥ 13.6 LSB	≥ 13.4 LSB	≥ 13.8 LSB	≥ 13.8 LSB	≥ 14.0 LSB	≥ 13.9 LSB	n.a.	n.a.
ENOB (based on SINAD)	≥ 13.1 LSB	≥ 13.4 LSB	≥ 13.4 LSB	≥ 13.7 LSB	≥ 13.6 LSB	≥ 13.8 LSB	n.a.	n.a.

(20 kHz measurements are missing the correct bandpass filter and therefore show a larger THD that is coming from the generator)

M2p.592x, DN2.592-xx, DN6.592-xx								
Test - sampling rate	20 MS/s							
Input Range	±200 mV		±500 mV		±1	±2 V		
Test Signal Frequency	1 MHz	n.a.	1 MHz	n.a.	1 MHz	n.a.	1 MHz	n.a.
SNR (typ)	≥ 77.2 dB	n.a.	≥ 79.8 dB	n.a.	≥ 81.0 dB	n.a.	≥ 75.0 dB	n.a.
THD (typ)	≤ 92.5 dB	n.a.	≤ -92.8 dB	n.a.	≤ -89.5 dB	n.a.	≤ -76.5 dB	n.a.
SFDR (typ), excl. harm.	≥ 103.0 dB	n.a.	≥ 103.0 dB	n.a.	≥ 105.0 dB	n.a.	≥ 93.0 dB	n.a.
ENOB (based on SNR)	≥ 12.5 LSB	n.a.	≥ 13.0 LSB	n.a.	≥ 13.2 LSB	n.a.	≥ 12.2 LSB	n.a.
ENOB (based on SINAD)	≥ 12.5 LSB	n.a.	≥ 13.0 LSB	n.a.	≥ 13.1 LSB	n.a.	≥ 11.8 LSB	n.a.

M2p.593x, DN2.593-xx, DN6.593-xx								
Test - sampling rate	40 MS/s							
Input Range	±200 mV		±500 mV		±1	±2 V		
Test Signal Frequency	1 MHz	10 MHz	1 MHz	10 MHz	1 MHz	10 MHz	1 MHz	10 MHz
SNR (typ)	≥ 73.0 dB	≥ 72.6 dB	≥ 74.6 dB	≥ 74.4 dB	≥ 75.3 dB	≥ 75.3 dB	≥ 71.9 dB	≥ 71.8 dB

M2p.593x, DN2.593-xx, DN6.593-xx								
THD (typ)	≤ -87.8 dB	≤ -67.0 dB	≤ -89.0 dB	≤ -67.0 dB	≤ -86.1 dB	≤ -67.2 dB	≤ -79.0 dB	≤ -67.2 dB
SFDR (typ), excl. harm.	≥ 98.3 dB	≥ 96.5 dB	≥ 98.8 dB	≥ 99.5 dB	≥ 101.0 dB	≥ 100.0 dB	≥ 81.7 dB	≥ 91.3 dB
ENOB (based on SNR)	≥ 11.8 LSB	≥ 11.8 LSB	≥ 12.1 LSB	≥ 12.0 LSB	≥ 12.2 LSB	≥ 12.2 LSB	≥ 11.7 LSB	≥ 11.6 LSB
ENOB (based on SINAD)	≥ 11.8 LSB	≥ 10.7 LSB	≥ 12.1 LSB	≥ 10.7 LSB	≥ 12.2 LSB	≥ 10.8 LSB	≥ 11.6 LSB	≥ 10.7 LSB

M2p.594x								
Test - sampling rate	80 MS/s							
Input Range	±200 mV		±500 mV		±1		±2 V	
Test Signal Frequency	1 MHz	10 MHz	1 MHz	10 MHz	1 MHz	10 MHz	1 MHz	10 MHz
SNR (typ)	≥ 70.6 dB	≥ 70.5 dB	≥ 72.9 dB	≥ 72.8 dB	≥ 74.2 dB	≥ 74.2 dB	≥ 69.8 dB	≥ 69.8 dB
THD (typ)	≤ -87.3 dB	≤ -76.9 dB	≤ -86.6 dB	≤ -76.3 dB	≤ -84.8 dB	≤ -70.1 dB	≤ -79.0 dB	≤ -77.9 dB
SFDR (typ), excl. harm.	≥ 97.5 dB	≥ 105.0 dB	≥ 101.0 dB	≥ 104.0 dB	≥ 100.0 dB	≥ 100.0 dB	≥ 96.9 dB	≥ 96.6 dB
ENOB (based on SNR)	≥ 11.4 LSB	≥ 11.4 LSB	≥ 11.8 LSB	≥ 11.8 LSB	≥ 12.0 LSB	≥ 12.0 LSB	≥ 11.2 LSB	≥ 11.2 LSB
ENOB (based on SINAD)	≥ 11.4 LSB	≥ 11.3 LSB	≥ 11.8 LSB	≥ 11.5 LSB	≥ 12.0 LSB	≥ 11.1 LSB	≥ 11.2 LSB	≥ 11.2 LSB

M2p.596x, DN2.596-xx, DN6.596-xx												
Test - sampling rate	125 MS/s											
Input Range	±200 mV			±500 mV			±1 V			±2 V		
Test Signal Frequency	1 MHz	10 MHz	40 MHz	1 MHz	10 MHz	40 MHz	1 MHz	10 MHz	40 MHz	1 MHz	10 MHz	40 MHz
SNR (typ)	≥ 68.1 dB	≥ 66.2 dB	≥ 65.5 dB	≥ 70.5 dB	≥ 69.9 dB	≥ 68.7 dB	≥ 73.3 dB	≥ 72.7 dB	≥ 71.5 dB	≥ 67.8 dB	≥ 65.8 dB	≥ 65.1 dB
THD (typ)	≤ -81.5 dB	≤ -74.5 dB	≤ -53.7 dB	≤ -82.5 dB	≤ -77.6 dB	≤ -55.3 dB	≤ -83.3 dB	≤ -68.9 dB	≤ -57.3 dB	≤ -78.0 dB	≤ -75.6 dB	≤ -53.7 dB
SFDR (typ), excl. harm.	≥ 95.0 dB	≥ 93.4 dB	≥ 92.3 dB	≥ 97.5 dB	≥ 96.8 dB	≥ 94.0 dB	≥ 98.5 dB	≥ 98.1 dB	≥ 96.4 dB	≥ 91.5 dB	≥ 89.0 dB	≥ 89.0 dB
ENOB (based on SNR)	≥ 11.0 LSB	≥ 10.7 LSB	≥ 10.6 LSB	≥ 11.4 LSB	≥ 11.3 LSB	≥ 11.1 LSB	≥ 11.8 LSB	≥ 11.8 LSB	≥ 11.6 LSB	≥ 11.0 LSB	≥ 10.6 LSB	≥ 10.5 LSB
ENOB (based on SINAD)	≥ 11.0 LSB	≥ 10.6 LSB	≥ 8.6 LSB	≥ 11.4 LSB	≥ 11.1 LSB	≥ 8.9 LSB	≥ 11.7 LSB	≥ 11.0 LSB	≥ 9.2 LSB	≥ 10.9 LSB	≥ 10.6 LSB	≥ 8.6 LSB

Dynamic parameters are measured at ±1 V input range (if no other range is stated) and 50Ω termination with the samplerate specified in the table. Measured parameters are averaged 20 times to get typical values. Test signal is a pure sine wave generated by a signal generator and a matching bandpass filter. Amplitude is >99% of FSR. SNR and RMS noise parameters may differ depending on the quality of the used PC. SNR = Signal to Noise Ratio, THD = Total Harmonic Distortion, SFDR = Spurious Free Dynamic Range, SINAD = Signal Noise and Distortion, ENOB = Effective Number of Bits.

Hardware block diagram

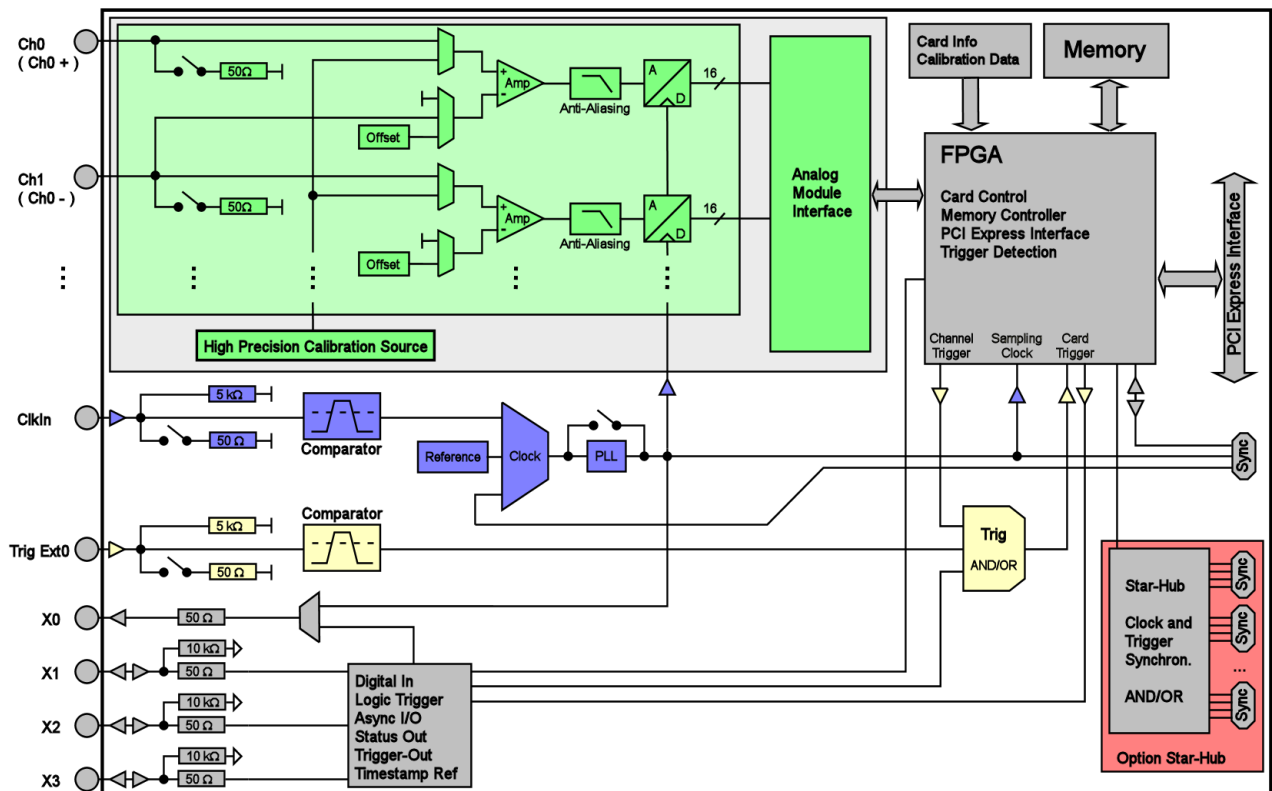

Order Information

The card is delivered with 512 MSample on-board memory and supports standard acquisition (Scope), FIFO acquisition (streaming), Multiple Recording, Gated Sampling, ABA mode and Timestamps. Operating system drivers for Windows/Linux 32 bit and 64 bit, examples for C/C++, LabVIEW (Windows), MATLAB (Windows and Linux), LabWindows/CVI, IVI, .NET, Delphi, Java, Python and a Base license of the oscilloscope software SBench 6 are included.

Adapter cables are not included. Please order separately!

PCI Express x4

Order no.	A/D Resolution	Standard mem	Single-Ended Inputs		Differential Inputs		
M2p.5911-x4	16 Bit	512 MSample	2 channels	5 MS/s	2 channels	5 MS/s	
M2p.5912-x4	16 Bit	512 MSample	4 channels	5 MS/s	2 channels	5 MS/s	
M2p.5916-x4	16 Bit	512 MSample	4 channels	5 MS/s	4 channels	5 MS/s	
M2p.5913-x4	16 Bit	512 MSample	8 channels	5 MS/s	4 channels	5 MS/s	
M2p.5920-x4	16 Bit	512 MSample	1 channel	20 MS/s	1 channel	20 MS/s	OEM only
M2p.5921-x4	16 Bit	512 MSample	2 channels	20 MS/s	2 channels	20 MS/s	
M2p.5922-x4	16 Bit	512 MSample	4 channels	20 MS/s	2 channels	20 MS/s	
M2p.5926-x4	16 Bit	512 MSample	4 channels	20 MS/s	4 channels	20 MS/s	
M2p.5923-x4	16 Bit	512 MSample	8 channels	20 MS/s	4 channels	20 MS/s	
M2p.5930-x4	16 Bit	512 MSample	1 channel	40 MS/s	1 channel	40 MS/s	OEM only
M2p.5931-x4	16 Bit	512 MSample	2 channels	40 MS/s	2 channels	40 MS/s	
M2p.5932-x4	16 Bit	512 MSample	4 channels	40 MS/s	2 channels	40 MS/s	
M2p.5936-x4	16 Bit	512 MSample	4 channels	40 MS/s	4 channels	40 MS/s	
M2p.5933-x4	16 Bit	512 MSample	8 channels	40 MS/s	4 channels	40 MS/s	
M2p.5940-x4	16 Bit	512 MSample	1 channel	80 MS/s	1 channel	80 MS/s	
M2p.5941-x4	16 Bit	512 MSample	2 channels	80 MS/s	2 channels	80 MS/s	
M2p.5942-x4	16 Bit	512 MSample	4 channels	80 MS/s	2 channels	80 MS/s	
M2p.5946-x4	16 Bit	512 MSample	4 channels	80 MS/s	4 channels	80 MS/s	
M2p.5943-x4	16 Bit	512 MSample	8 channels	80 MS/s	4 channels	80 MS/s	
M2p.5960-x4	16 Bit	512 MSample	1 channel	125 MS/s	1 channel	125 MS/s	
M2p.5961-x4	16 Bit	512 MSample	2 channels	125 MS/s	2 channels	125 MS/s	
M2p.5962-x4	16 Bit	512 MSample	4 channels	125 MS/s	2 channels	125 MS/s	
M2p.5966-x4	16 Bit	512 MSample	4 channels	125 MS/s	4 channels	125 MS/s	
M2p.5968-x4	16 Bit	512 MSample	4 channels	125 MS/s	4 channels	125 MS/s	
			8 channels	80 MS/s			

Options

Order no.	Option
M2p.xxxx-SH6ex ⁽¹⁾	Synchronization Star-Hub for up to 6 cards incl. cables, only one slot width, card length 245 mm
M2p.xxxx-SH6tm ⁽¹⁾	Synchronization Star-Hub for up to 6 cards incl. cables, two slots width, standard card length
M2p.xxxx-SH16ex ⁽¹⁾	Synchronization Star-Hub for up to 16 cards incl. cables, only one slot width, card length 245 mm
M2p.xxxx-SH16tm ⁽¹⁾	Synchronization Star-Hub for up to 16 cards incl. cables, two slots width, standard card length
M2p.xxxx-DigFX2	16 additional multi-purpose I/O lines on separate slot bracket, FX2 connector
M2p.xxxx-DigSMB	16 additional multi-purpose I/O lines, 10 on separate slot bracket, 6 internal connectors
M2p-upgrade	Upgrade for M2p.xxxx: Later installation of option Star-Hub

Services

Order no.	
Recal	Recalibration at Spectrum incl. calibration protocol

Cables

for Connections	Length	Order no.				
		to BNC male	to BNC female	to SMA male	to SMA female	to SMB female
Analog/Clock-In/Trig-In	80 cm	Cab-3f-9m-80	Cab-3f-9f-80	Cab-3f-3mA-80	Cab-3f-3fA-80	Cab-3f-3f-80
Analog/Clock-In/Trig-In	200 cm	Cab-3f-9m-200	Cab-3f-9f-200	Cab-3f-3mA-200	Cab-3f-3fA-200	Cab-3f-3f-200
Probes (short)	5 cm		Cab-3f-9f-5			
Clk-Out/Trig-Out/Extra	80 cm	Cab-1m-9m-80	Cab-1m-9f-80	Cab-1m-3mA-80	Cab-1m-3fA-80	Cab-1m-3f-80
Clk-Out/Trig-Out/Extra	200 cm	Cab-1m-9m-200	Cab-1m-9f-200	Cab-1m-3mA-200	Cab-1m-3fA-200	Cab-1m-3f-200
Information	The standard adapter cables are based on RG174 cables and have a nominal attenuation of 0.3 dB/m at 100 MHz.					

Amplifiers

Order no.	Bandwidth	Connection	Input Impedance	Coupling	Amplification
SPA.1412 ⁽²⁾	200 MHz	BNC	1 MOhm	AC/DC	x10/x100 (20/40 dB)
SPA.1411 ⁽²⁾	200 MHz	BNC	50 Ohm	AC/DC	x10/x100 (20/40 dB)
SPA.1232 ⁽²⁾	10 MHz	BNC	1 MOhm	AC/DC	x100/x1000 (40/60 dB)
SPA.1231 ⁽²⁾	10 MHz	BNC	50 Ohm	AC/DC	x100/x1000 (40/60 dB)
Information	External Amplifiers with one channel, BNC/SMA female connections on input and output, manually adjustable offset, manually switchable settings. An external power supply for 100 to 240 VAC is included. Please be sure to order an adapter cable matching the amplifier connector type and matching the connector type for your A/D card input.				

Software SBench6

Order no.	
SBench6	Base version included in delivery. Supports standard mode for one card.
SBench6-Pro	Professional version for one card: FIFO mode, export/import, calculation functions
SBench6-Multi	Option multiple cards: Needs SBench6-Pro. Handles multiple synchronized cards in one system.
Volume Licenses	Please ask Spectrum for details.

Software Options

Order no.	
SPc-RServer	Remote Server Software Package - LAN remote access for M2i/M3i/M4i/M4x/M2p cards
SPc-SCAPP	Spectrum's CUDA Access for Parallel Processing - SDK for direct data transfer between Spectrum card and CUDA GPU. Includes RDMA activation and examples. Signed NDA needed for access.

⁽¹⁾ : Just one of the options can be installed on a card at a time.

⁽²⁾ : Third party product with warranty differing from our export conditions. No volume rebate possible.

Technical changes and printing errors possible

SBench, digitizerNETBOX and generatorNETBOX are registered trademarks of Spectrum Instrumentation GmbH. Microsoft, Visual C++, Windows, Windows 98, Windows NT, Window 2000, Windows XP, Windows Vista, Windows 7, Windows 8 and Windows 10 are trademarks/registered trademarks of Microsoft Corporation. LabVIEW, DASyLab, Diadem and LabWindows/CVI are trademarks/registered trademarks of National Instruments Corporation. MATLAB is a trademark/registered trademark of The Mathworks, Inc. Delphi and C++Builder are trademarks/registered trademarks of Embarcadero Technologies, Inc. Keysight VEE, VEE Pro and VEE OneLab are trademarks/registered trademarks of Keysight Technologies, Inc. FlexPro is a registered trademark of Weisang GmbH & Co. KG. PCIe, PCI Express and PCI-X and PCI-SIG are trademarks of PCI-SIG. LXI is a registered trademark of the LXI Consortium. PICMG and CompactPCI are trademarks of the PCI Industrial Computation Manufacturers Group. Oracle and Java are registered trademarks of Oracle and/or its affiliates. Intel and Intel Core i3, Core i5, Core i7, Core i9 and Xeon are trademarks and/or registered trademarks of Intel Corporation. AMD, Opteron, Sempron, Phenom, FX, Ryzen and EPYC are trademarks and/or registered trademarks of Advanced Micro Devices. NVIDIA, CUDA, GeForce, Quadro and Tesla are trademarks/registered trademarks of NVIDIA Corporation.